

Bose Work

Conferencing Solutions

BOSE

Application Guide



Videobar™ VB1

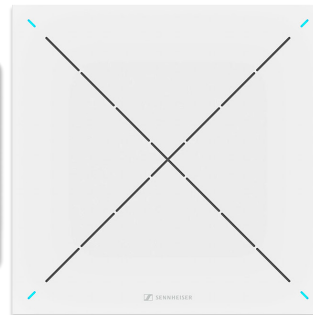
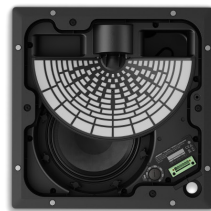

ES1 Ceiling Audio Solution

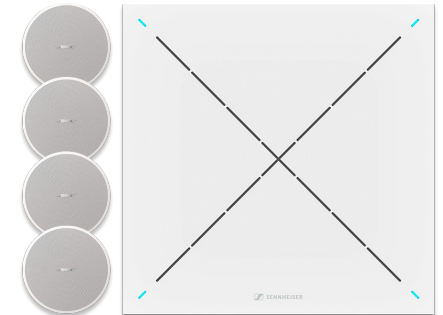

DS4 Ceiling Audio Solution

WHAT'S IN THIS GUIDE

It explains the Bose approach to conferencing applications. This includes information about how Bose defines and segments the application types. It covers our conferencing products with system examples showcasing the key features and technologies that most matter to each application. While each application or use case may vary, this guide serves as a good starting point on how to choose the right solution for your specific application.

ONLINE TECHNICAL TRAINING PROGRAMS - FREE OF CHARGE

Located at [PRO.BOSE.COM/LEARNINGCENTER](https://pro.bose.com/learningcenter)

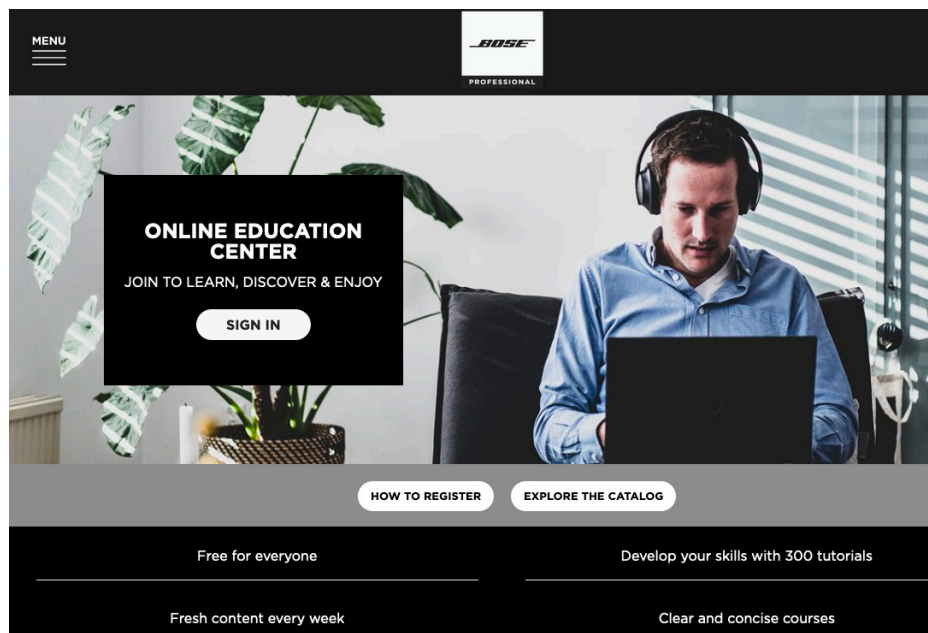

Bose provides comprehensive online training programs for in-depth technical knowledge. These online courses are multimedia-rich and make learning enjoyable. They are open to the public with free registration. Bose provides multiple learning methods to best match your style. You can choose Certification, OnDemand, or Webinar.

For those who prefer to gain a certificate of completion, Bose provides a step-by-step learning course with a quiz assessment. Once passed, you are granted a Bose certificate.

For those who prefer to pick and choose, Bose provides an OnDemand section with micro-learning tutorials. Each is modularized so you can pick and choose what you desire to learn. You can start OnDemand and easily convert to certification later.

For those who prefer webinars, Bose provides a webinar method with upcoming and past webinars that can be watched or attended.

We hope you take advantage of the technical training programs so you can become a Bose tech expert.

CONFERENCING DEFINED	3	BOSE VIDEOBAR™ VB1: HUDDLE ROOMS.....	15
INTEGRATED ROOMS EXPLAINED	4	BOSE VIDEOBAR™ VB1: MEDIUM CONFERENCE ROOMS.....	17
NON-INTEGRATED ROOMS EXPLAINED	5	BOSE VIDEOBAR™ VB1: MOBILE CONFERENCE CARTS.....	19
BYOM VS. HOST PC EXPLAINED	6	BOSE INTEGRATED SYSTEM SOLUTIONS	21
WELCOME TO BOSE WORK	7	BOSE ES1 CEILING AUDIO SOLUTION: OVERVIEW.....	23
BOSE VIDEOBAR™ VB1.....	9	BOSE DS4 CEILING AUDIO SOLUTION: OVERVIEW.....	24
BOSE VIDEOBAR™ VB1: HARDWARE	10	BARCO CLICKSHARE WIRELESS SOLUTIONS	25
BOSE VIDEOBAR™ VB1: SOFTWARE SUITE	11	BARCO CLICKSHARE SOLUTIONS: SYSTEM DIAGRAMS	27
BOSE VIDEOBAR™ VB1: BYOM OR HOSTED MEETING DIAGRAM	12	HP ELITE SLICE G2 AUDIO READY	28
BOSE VIDEOBAR™ VB1: FOCUS AREAS & MEETING BOOTHS	13	HP ELITE SLICE G2 AUDIO READY: SYSTEM DIAGRAM	29



The workplace is everywhere today. It has evolved as the business world has become more globalized and less centralized. Companies find their workforce situated in various geographic locations. The workplace landscape now includes satellite sites, home offices, cars, and even coffee shops. This trend towards a decentralized workforce has changed how we collaborate as digital communication is quickly becoming preferable than sitting in the same space together.

This fast growth towards decentralization is a business challenge and driving the demand for better conferencing and collaboration tools. Business owners, IT professionals, and facility managers from all organization sizes are seeking solutions to improve the workforce agility, collaboration, and performance.

Conferencing is the market defining these improvements. It refers to locations using analog or digital communication methods from one sender to many receivers in separate locations. The conferencing world has moved beyond standard audio conversations. Today's workforce and their customers alike want a more immersive way to connect, and for many, that means using video conferencing.

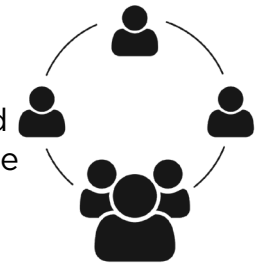

Video conferencing is a growing trend. It offers one-on-one or group conversations to include a face-to-face experience for everyone involved. With video conferencing, remote workers can feel like they are in the same room without having to worry about travel requirements.

Bose segments conferencing into two application room types.



Integrated Rooms



Non-Integrated Rooms

These spaces are purpose built with audio or video conferencing in mind. Businesses continue to deploy a handful of high-end large conference or boardrooms packed with the latest technology. These spaces are commonly designed to accommodate more than 12 people and require more complex equipment for effective large group participation.

Though common in corporate conference rooms, integrated conference systems can also be found in lecture halls, classrooms, distance learning, court rooms, government buildings, or any other application requiring two-way real-time communication.

Integrated system solution

A typical system includes sophisticated cable infrastructure with integrated devices such as large video displays, microphones, loudspeakers, automated lighting, and advanced system control mounted into the ceiling, walls, and tables. They also require an equipment rack to house computers, system controllers, signal processors, amplifiers, network equipment and more.

Due to their complexity, they require skilled specialists to properly design, program and install the system with routine system maintenance.



Large Conference Rooms



Executive Boardrooms



Conference Suites

These spaces are the fastest-growing application types. They are intended to serve multiple uses cases including conferencing. This allows for maximum flexibility and cost-effective use of space in a modern office building. These room types are medium to small in size—such as small conference rooms, huddle rooms, focus areas, and meeting booths—and accommodate fewer than 12 participants.

Workers can huddle immediately and reach an external audience using the conferencing system for remote colleagues and partners. Studies show workers prefer them and feel more comfortable speaking up in smaller group settings, resulting in better collaboration.

Non-integrated system solution

With their multipurpose design, the conferencing system typically features a video display, camera, microphone, audio system, and connectivity for BYOM (Bring Your Own Meeting) support. The market desire is simple, self-contained solutions that integrate these capabilities together with easy installations.

The fastest-growing tech is the compact, all-in-one videobar with sound, mic and camera integration. The videobars are positioned above or below the video display with simple connection.



Mid to Small Conference Rooms



Huddle Rooms



Focus Areas

Non-integrated rooms are defined and segmented into two subcategories:

Bring Your Own Meeting (BYOM)



The video conference is hosted on the user's own computer or smart device brought into the room, using their preferred UC conferencing service such as Microsoft Teams, Google Meet, Zoom and more. The user's device connects to the room's provided audio and video peripherals so room participants can collaborate. These BYOM rooms benefit users who come with familiarity of their own device.

The disadvantage is a high dependency on the user's device being prepared for connection to the room's audio and video peripherals and comes with sufficient internet speed to host the conference call.

Hosted Meeting



The video conference is hosted on a purpose-built and preconfigured PC that stays in the room. The UC conferencing service is prepared for operation. It doesn't require the user to bring their own device, and the host PC is already connected to the room's audio, video, and network peripherals.

The disadvantage is the user needing to properly learn how to operate the system and their frustration when something is not working correctly.

Bose Work is our category of technology solutions for unified communications and conferencing. They bring the simplicity and clarity of Bose to huddle spaces, desktop and mobile conferencing, and large meeting rooms.

Bose Work solutions integrate seamlessly with existing UC platforms, enhancing popular third-party cloud services. They help teams collaborate more effectively, moving beyond “good enough” audio and video so interactions are natural and people can hear more, see more, understand more — and work better.



BOSE VIDEOBAR™ VB1

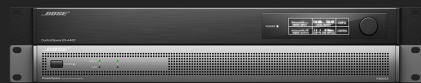
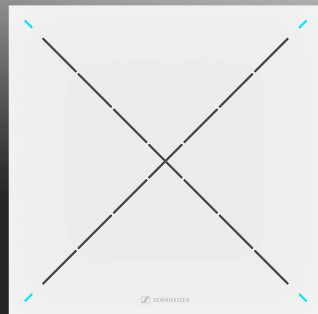

BOSE ES1 CEILING AUDIO SOLUTION

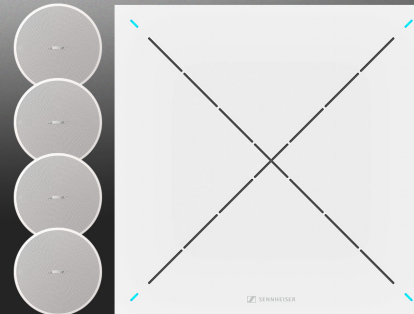
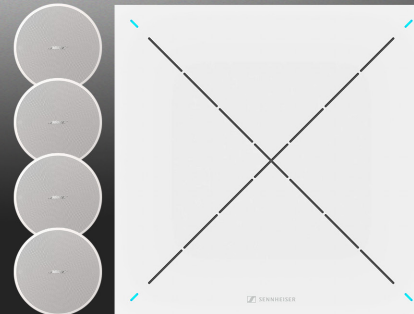

BOSE DS4 CEILING AUDIO SOLUTION

STRATEGIC PARTNERS

We recognize that Bose Work's tremendous growth in the unified communications and video conferencing market would not be possible without our partners. Through our strategic partnerships, we are able to offer complete collaboration solutions our customers know and trust. Together, we ensure solutions are certified and compatible with the industry's most popular UC environments and offer superior user experiences wherever you are.

The Bose partner network is a rich ecosystem of UC providers, technology partners, and collaboration specialists.



TECHNOLOGY PARTNERS

The Bose Technology Partner Program is designed to support and extend end-to-end solutions that address our customers' communication challenges. Together with our technology partners we develop and deliver high-quality solutions that enhance communication and collaboration.

Our partnerships enable us to bring more innovation, more options, and better user experiences to our customers.



The Bose Videobar™ VB1 is an all-in-one USB conferencing device that brings premium audio and video to small meeting areas — from huddle spaces to medium-sized rooms. Be seen clearly. Be heard and understood fully. Six beam-steering microphones automatically focus on voices in the room and reject noise. A 4K ultra-HD camera with autoframing delivers crystal-clear video, helping remote participants feel like they're in the room. Proprietary Bose sound supports multimedia presentations, plays *Bluetooth*® audio, and ensures voices on the call sound natural.

Single-cable connectivity means there's no need for separate audio and video cables at the table, reducing clutter. Whether it's a quick morning check-in or a full-afternoon workshop, the Bose Videobar™ VB1 helps you huddle up, see more, hear more, and work better.

KEY FEATURES

Certified for Microsoft Teams.



Make conversations more natural with six beam-steering microphones that actively focus on voices and reject noise; and auto EQ that delivers optimized audio to all participants.

Communicate and be seen more clearly — a 4K ultra-HD camera with autoframing allows everyone to see and understand the presenter, whiteboard, flipchart, or other in-room objects — and feel more like they're together in the same room.

Bring enhanced video and audio performance to popular Unified Communications platforms such as Microsoft Teams, Google Meet, Zoom, and more.

Support multimedia presentations with premium audio with Bose-proprietary transducers that deliver room-filling sound from a USB-connected laptop or wireless Bluetooth® device.

Clean up the conferencing experience with an elegant low-profile design that complements the room, improves aesthetics, and connects via a single USB cable, eliminating clutter.

Easily mount in multiple ways with included table stand and wall-mount kit or with mounting kit accessory (sold separately).

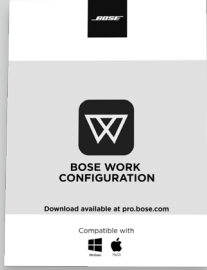
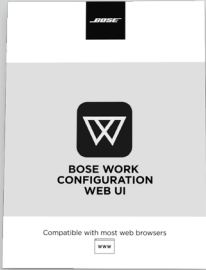
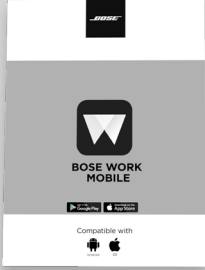
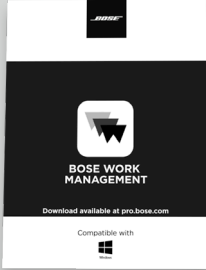
	BOSE WORK CONFIGURATION	BOSE WORK CONFIGURATION WEB UI	BOSE WORK MOBILE APP	BOSE WORK MANAGEMENT
				
Description	Provides user control of the camera and audio settings via the homepage and password-protected configuration settings via the Administration tab	Provides administrators remote management of a single Bose Videobar™ VB1	Provides a meeting user control over camera position, camera presets, autoframing, microphone mute, volume, and <i>Bluetooth</i> connectivity	Provides enterprise-level remote management and system admin access to multiple Videobar™ VB1 devices installed on a local network.
Intended users	System admins and users	System admins	Users	System admins
Operating system	Windows and Mac OS	Web browser	iOS and Android	Windows
Download location	PRO.BOSE.COM	PRO.BOSE.COM	App Store SM or Google Play TM	PRO.BOSE.COM
Connection method	USB	Wired and wireless network	<i>Bluetooth</i> LE	Wired and wireless network
Remote management	No	Yes	No	Yes
Firmware updates	One device at a time	One device at a time	No	Batch updates supported
Profile upload and download	One device at a time	One device at a time	No	Single-device download with multiple-device upload

BOSE VIDEOBAR™ VB1: BYOM OR HOSTED MEETING DIAGRAM

BOSE WORK

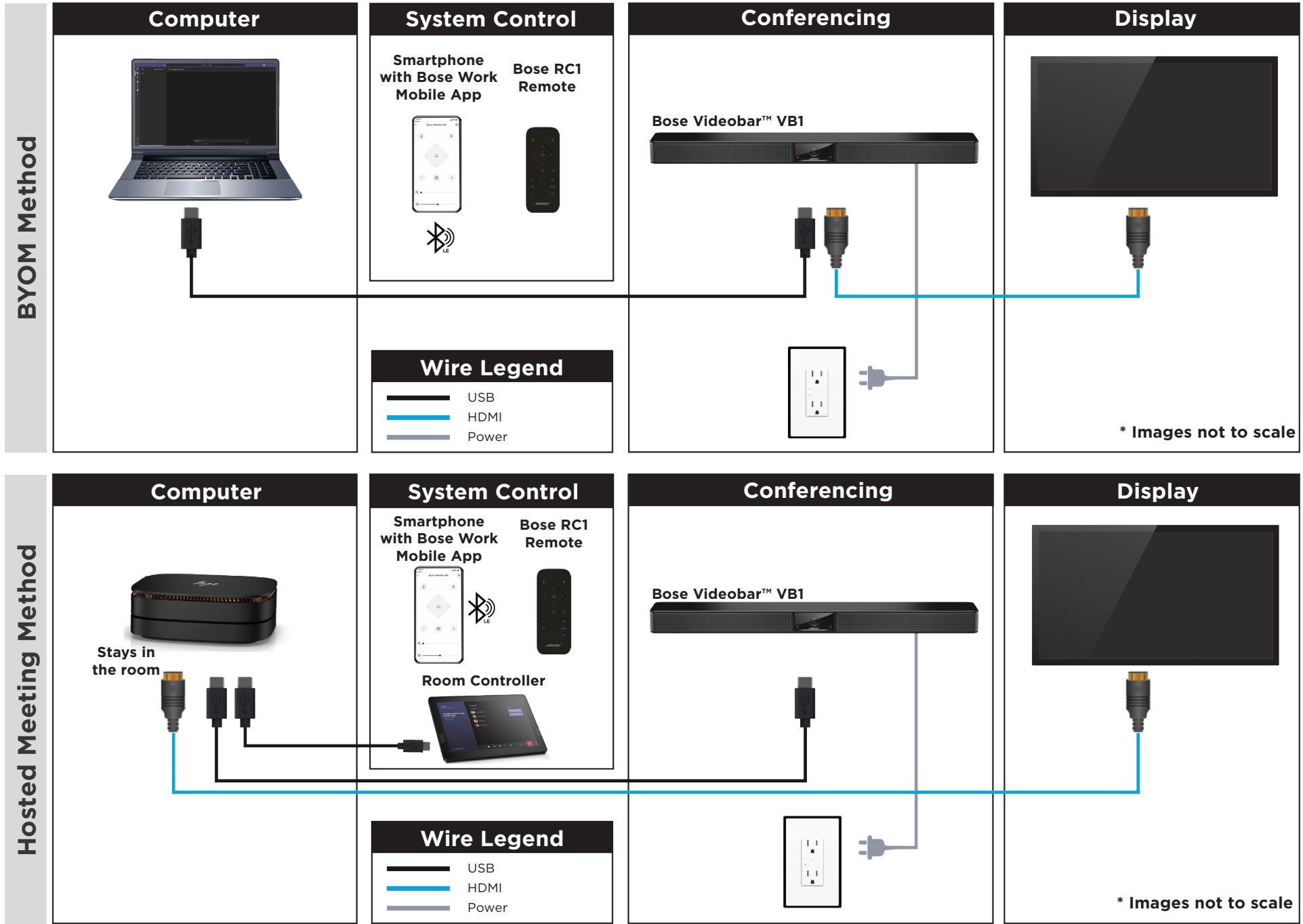

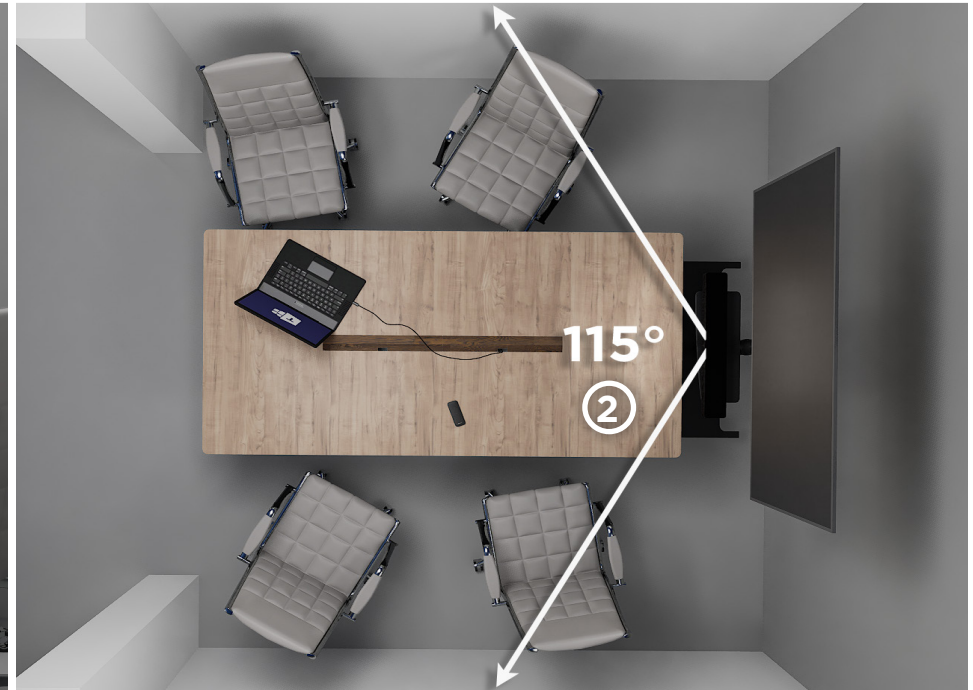

Focus areas and meeting booths are typically compact, open spaces that accommodate two to four people. They are popular in open-cubicle office environments. They allow small groups to quickly host brief impromptu meetings.

Users typically bring their own meeting device such as a laptop. Speed is important as they desire quick connections and simple operation so they can focus on their conference calls instead.

The Bose Videobar™ VB1 meets these necessary requirements and provides much more. Here is a feature spotlight of what matters most to focus areas and meeting booths:

- ① **Plug-and-play operation** allows the VB1 to be pulled out of the box, connected via USB-C into a BYOM device and used in your UC meeting without any prior setup. It behaves as a USB peripheral for microphone, speakerphone, and camera.
- ② **Wide-angle camera** provides a 115° horizontal field of view. It is excellent for participants located close to the display. This means that even in a very small space there is no need to lean in to be seen by the remote participants like a standard laptop camera.
- ③ **Easy-to-operate remote** is included in the packaging. This IR remote control allows users to easily adjust basic settings like volume, zoom, pan, autoframing, mute, and Bluetooth® pairing without downloading any apps or launching any programs.
- ④ **One-cable connection** allows users to connect their computing device using a single USB-C cable. All audio, video, and data are streamed to the Videobar™ VB1 for the video display, microphone, speaker, and camera. This means there is no more fiddling with various video and audio connectors. Just connect one cable and you're ready to start the meeting.
- ⑤ **Wireless connection for conference calls** allows users to host an impromptu audio conference via *Bluetooth* enabled device. Simply pair your mobile device, and then others can join the call via their preferred UC application or playback music.

BOSE VIDEOBAR™ VB1: HUDDLE ROOMS

BOSE WORK

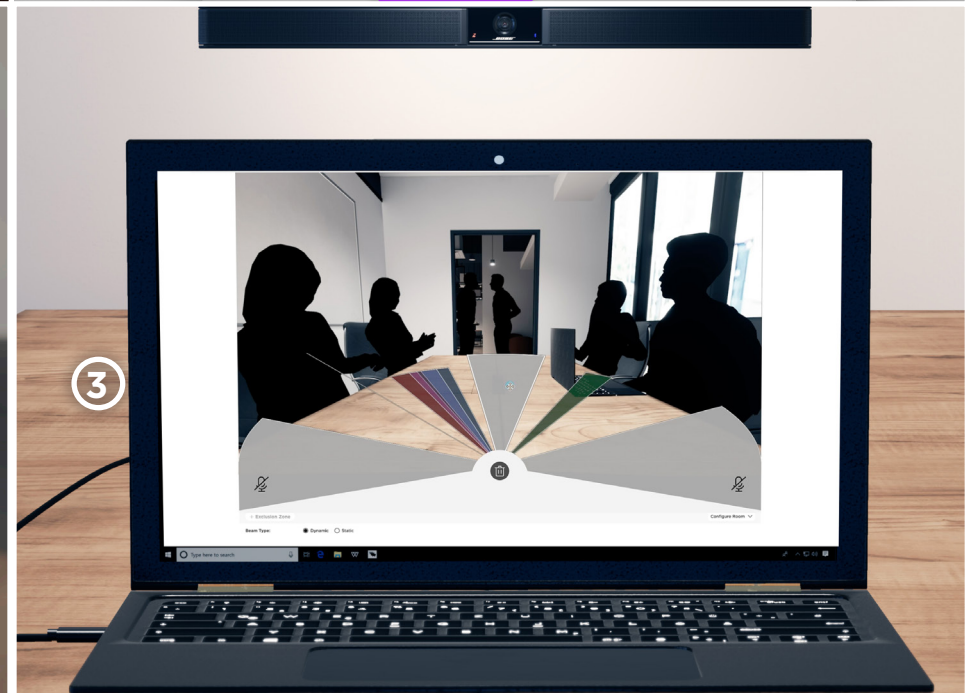
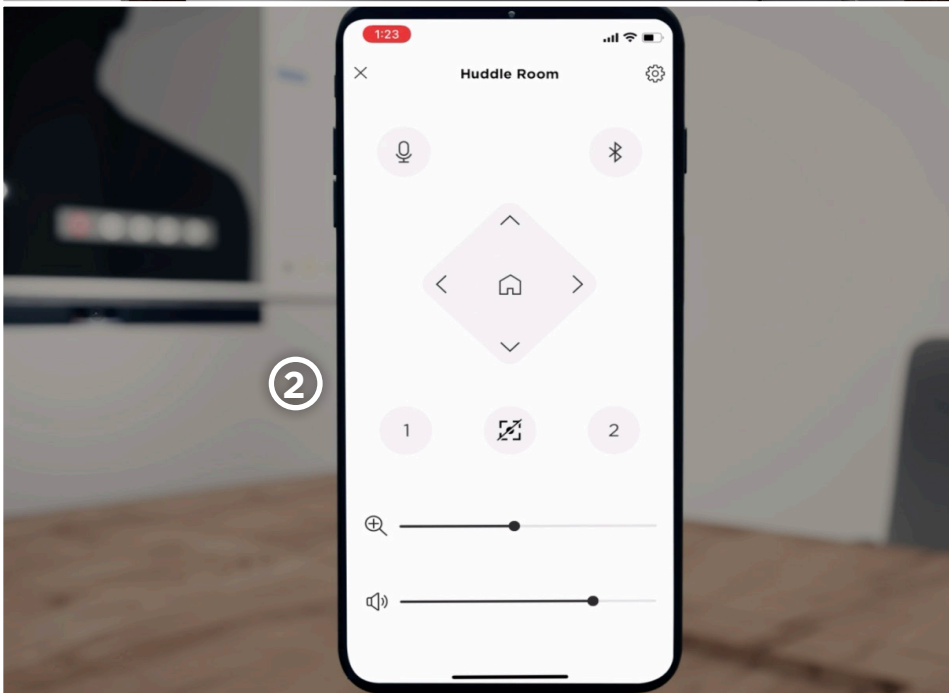
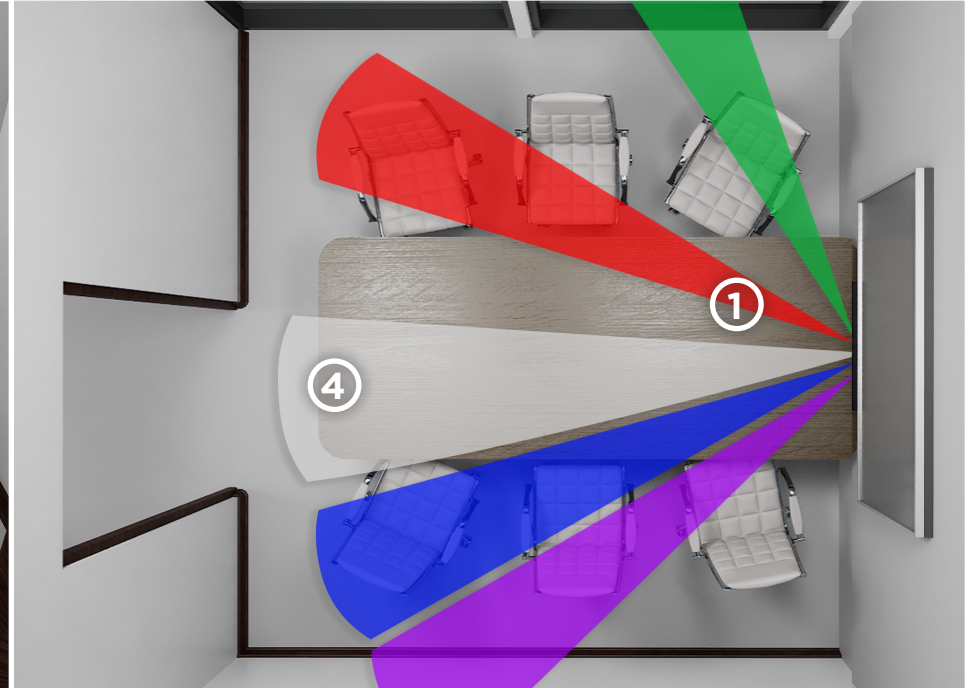

Huddle rooms are the fastest-growing conferencing spaces due to the popularity of open office concepts. While the goal is to inspire more spontaneous collaboration, studies have shown open office plans decrease productivity and employee well-being, while increasing the number of sick days workers take. The constant noise and distractions from the open space make collaboration difficult amongst a group of people. So, the answer is flexible meeting spaces, known as huddle rooms.

With workers preferring huddle rooms, companies are shifting purchases towards conferencing additions to these spaces. Initially, it started with an audio conference phone placed in the center of the table. As cloud UC services like Microsoft Teams, Google Meet, and Zoom have boomed, the rooms' technology evolved into video conference functionality.

These rooms typically facilitate up to eight people, come equipped with a video display, and may also have a whiteboard. The Bose Videobar™ VB1 can substantially simplify and create a more tailored room experience that makes installation extremely efficient and enjoyable to use.

Expanding the use cases for the Bose Videobar™ VB1, it is an ideal solution for huddle rooms. Here is a feature spotlight of what matters most:

- ① **Adaptive beam-steering microphones** made up of six mic elements that digitally form into four discrete beams. Each wideband beam provides narrow pickup that automatically and dynamically aims at the people speaking in the space. This minimizes room reverberations or hollow sound for remote participants and keeps the conversation flowing smoothly without syllables being dropped or voices ramping up and down.
- ② **Bose Work Mobile App** provides simple system control using an Apple iOS or Android mobile smartphone or tablet. It operates via *Bluetooth*® connection. You can adjust volume, mute, camera pan, zoom, and autoframing all from your mobile device. It can be downloaded from the App StoreSM or Google PlayTM.
- ③ **Bose Work Configuration App** offers dual purpose use as it provides a user control home screen like the Bose Work Mobile App. The second use is the secured admin section that offers installers and administrators access to the full suite of configuration settings.
- ④ **Up to three exclusion zones** can be configured to exclude certain areas from microphone pickup such as an open doorway or entrance so the microphones will not search this area for voice pickup. This feature provides optimal performance when used in an open environment. When used in a closed space, the room reflections could limit best results.

BOSE VIDEOBAR™ VB1: MEDIUM CONFERENCE ROOMS

BOSE WORK

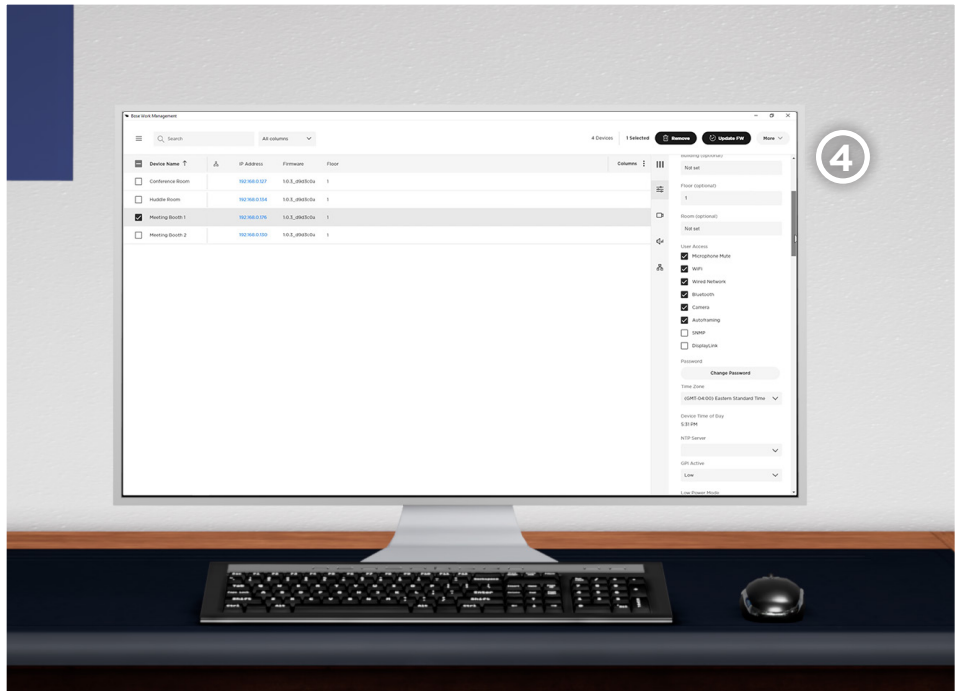
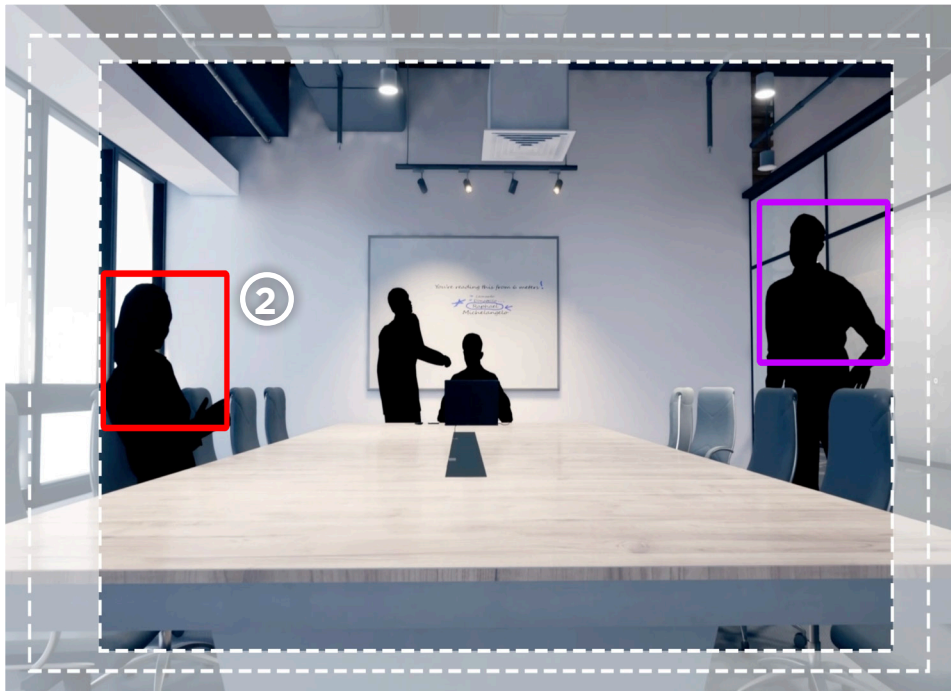
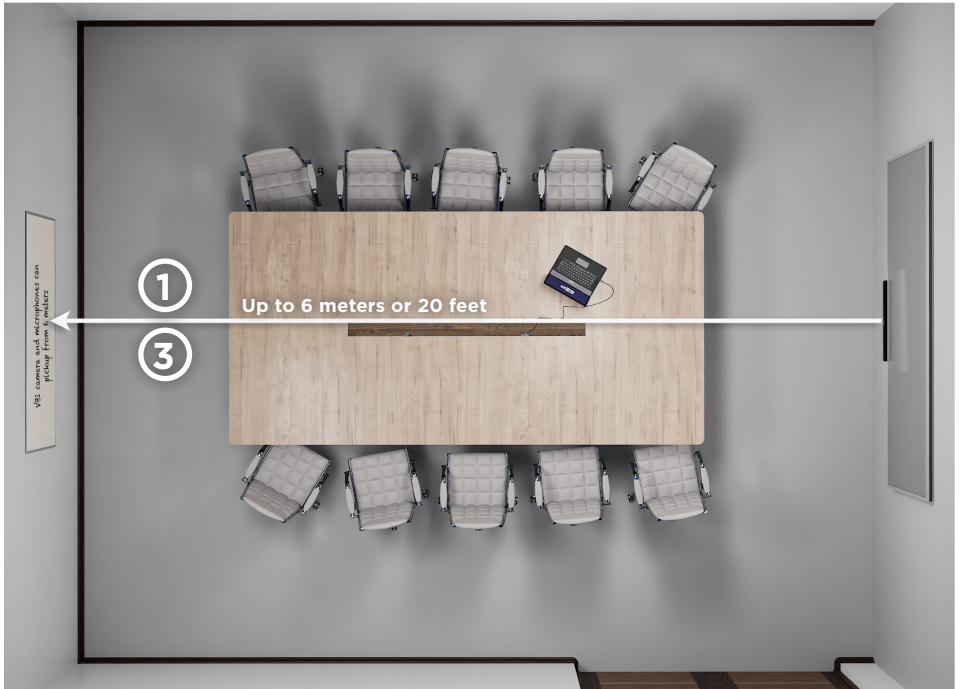

Non-integrated conferencing systems are being used in larger spaces that go beyond their intended use such as small-to-medium conference rooms. These conference rooms are the most demanding spaces for non-integrated conferencing systems due to the number of participants and room space. They typically facilitate up to ten people with a room depth up to six meters or 20 feet. Most compact USB conferencing devices are not designed for these extended use cases, and it becomes a list of compromises:

Limited voice pickup for half the room as the internal microphones do not adequately pick up people at the other end of the room, so a supplement microphone accessory is installed typically on the table. This adds complexity, table noise, and a point of failure.

Poor sound levels as the internal loudspeaker output is not loud enough for larger spaces, so the users must deal with either low output levels or distortion because the devices are being pushed past their intended sound levels.

Grainy camera resolution for half the room as the internal cameras are not intended for text pickup at longer distances.

The Bose Videobar™ VB1 sets a new standard for the size of room in which an all-in-one solution can perform without compromises. These are the main features that expand its use into these larger spaces.

- ① **4K digital zoom** allows remote participants to read text written on whiteboards from up to six meters or 20 feet. They can see the entire meeting space with visual clarity.
- ② **Autoframing** allows the VB1 to automatically adjust the pan, tilt and zoom to keep all meeting participants in frame during your meeting.
- ③ **Microphone pickup distance** can pick up voices up to 20 feet (6 meters) away due to the adaptive beam-steering microphone array. The consistent clarity simply cannot be understated and no supplemental microphone is required.
- ④ **Remote system management** allows system administrators to remotely diagnose, update, and maintain the Bose Videobar™ VB1 wherever it is installed. With both WiFi or physical network connections, all features of the VB1 can be remotely monitored and maintained. If operation problems happen, the VB1 can be easily restored to maintain scheduled meetings on time without administrators having to be present in the room.



With remote work becoming the norm, mobility is crucial around an office environment. A growing trend is conferencing carts that allow the conferencing system to be easily moved around the facility to turn any place into a meeting space. The user's desire is a self-contained system that can be wheeled into the area, and the video conference can happen promptly with no technical difficulties.

These systems include everything integrated into the mobile cart. The video display, host PC, user controls, microphone, camera, and loudspeakers are all included. These solutions provide maximum flexibility and offer cost-saving measures when a traditional huddle or conference room may not be an option.

The Bose Videobar™ VB1 incorporates technology that makes it a great solution for mobile conference carts. These features spotlight why:

- ① **The slim design with optional mounting system** is so compact that it fits on a cart shelf, or you can remove the tabletop mount and install it under or above the video display using its optional mounting accessories.
- ② **Onboard WiFi network card** allows wireless network connection. Once AC powered, the VB1 conference cart will connect to your organizations Wi-Fi network allowing full utilization.
- ③ **Just plug in AC power** is the only hardwired connection required. The rest of the system is self contained so you can host a video conference anywhere in your facility.
- ④ **HDMI output from the Videobar™ VB1** allows the video display to be directly connected using DisplayLink® driver technology.
- ⑤ **Unparalleled microphone flexibility** is accomplished by the wide pickup pattern of the beam-steering microphone arrays. Whether you are in a corner, a large open space, or a small room, the Bose Videobar™ VB1 is the perfect device to complete a mobile conferencing cart.



**Bose ES1 Ceiling
Audio Solution**

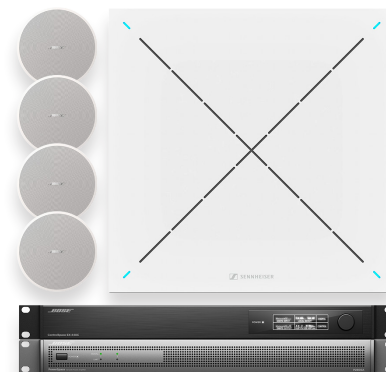

**Bose DS4 Ceiling
Audio Solution**

Clear the conference table for better collaboration. Part of the Bose Work family of conferencing products, the Bose Ceiling Audio Solutions are complete conferencing systems for fully integrated meeting rooms. They combine the premium performance of Bose loudspeakers and Sennheiser TeamConnect Ceiling 2 microphone — along with a Bose amplifier and DSP — to deliver a seamless meeting experience that empowers productivity. They're complete room audio solutions, ready for quick deployment and configuration of the electronics, reducing installation time.

A Bose Ceiling Audio Solution is more than fully integrated — it's truly integrated. Completely out of the way. With fewer devices on walls and tabletops, meeting participants can stand, sit, or move around the room freely with the confidence that they'll hear and be heard.



KEY FEATURES

Certified for Microsoft Teams and compatible with Zoom. Plus, certified for use with Avaya® and Cisco® VoIP systems



Deliver a truly integrated premium conferencing solution, combining Bose loudspeakers, Sennheiser TeamConnect Ceiling 2 microphone, ControlSpace EX-440C processor, and PowerSpace P2600A amplifier

Choose from two systems — the innovative Bose ES1 system, featuring one EdgeMax EM180 loudspeaker, or the more conventional Bose DS4 system, featuring four DesignMax DM2C-LP loudspeakers

Clean up the conferencing experience with fewer devices on walls or tabletops, giving people the freedom to focus on work, the flexibility to sit or stand anywhere in the room, and the confidence that they'll hear and be heard clearly

Bring clarity and intelligibility to large meeting rooms with superior echo-cancelling technology, so remote meeting participants can communicate freely and feel like they're in the room

Deploy quickly with reference configurations that help reduce installation time

Combine with popular unified communications platforms such as Microsoft Teams, Zoom, Google Meet, and more, to provide enhanced audio performance in fully integrated meeting rooms

Build trust with end-users by offering an integrated conferencing solution from globally respected audio companies that they already know and recognize as premium brands

BASIC SYSTEM SIGNAL FLOW

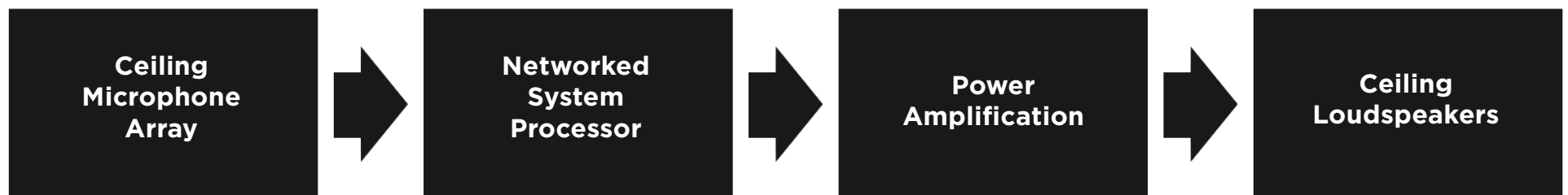

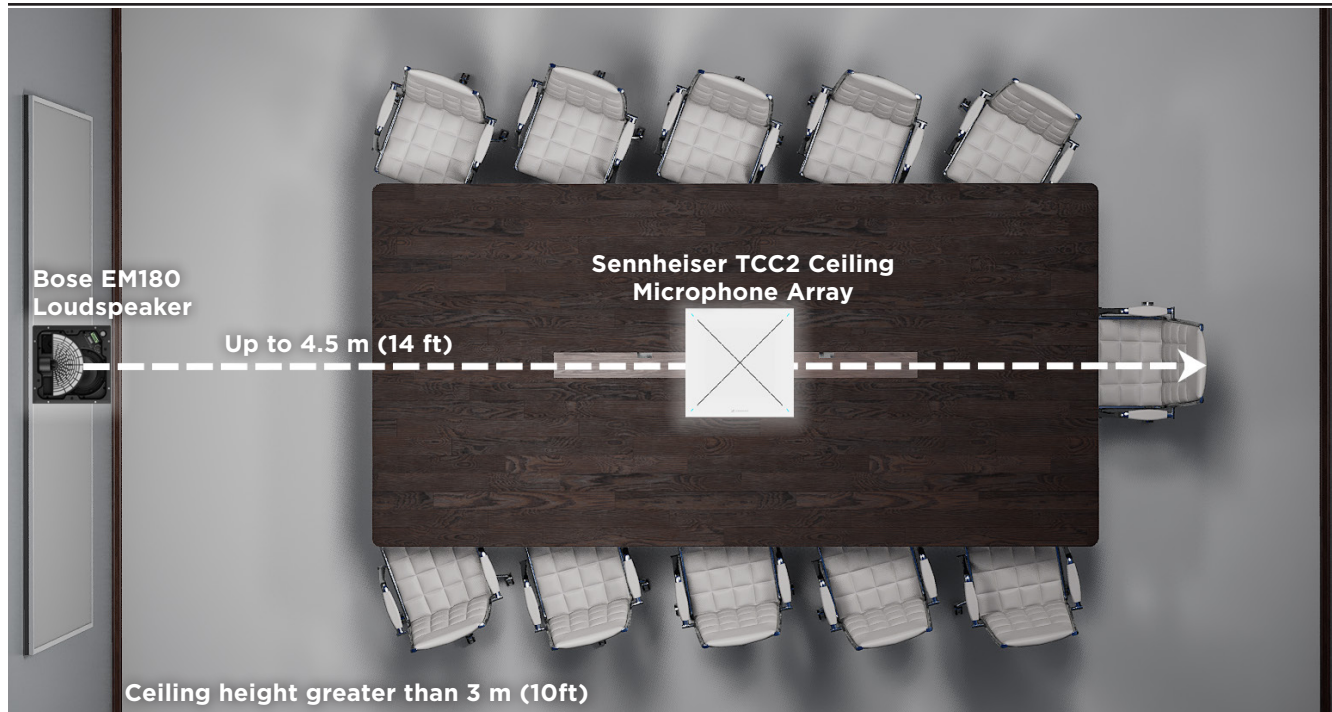

Microphone Array: The Sennheiser TeamConnect Ceiling 2 provides a patented automatic voice location detection and dynamic beamforming to capture a talker's voice no matter where they are located in the room. It quickly switches between multiple voices and it's great for rooms with flexible seating configurations.

Networked System Processor: The Bose ControlSpace EX-440C conferencing signal processor facilitates high-quality microphone integration and audio processing. Various inputs and outputs allow for flexible configuration, with four mic/line analog inputs, four analog outputs, onboard VoIP and PSTN, USB, Bose AmpLink output, eight-channel acoustic echo cancelling (AEC), and 16 x 16 Dante® connectivity.

Power Amplification: To power the EdgeMax EM180, the PowerSpace P2600A provides 600 watts per channel, and the Bose AmpLink connection provides uncompressed, low-latency digital audio from the ControlSpace processor via a network cable.

Loudspeakers: The Bose EdgeMax EM180 loudspeaker is a revolutionary new type of ceiling loudspeaker — it's best explained as a large-format, surface-mount loudspeaker hidden away in a flush ceiling-mount. With a single unit, it provides 180° coverage with unparalleled sound performance due to the Bose PhaseGuide technology. The result is high-definition sound performance that fills the entire room for all participants

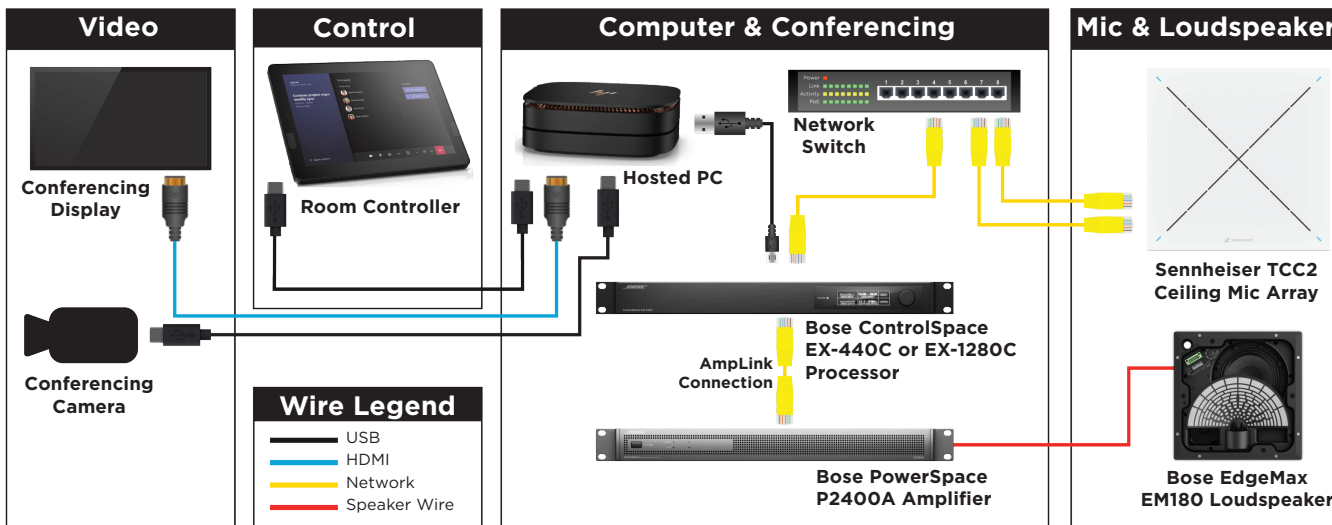

* Images not to scale

BOSE DS4 CEILING AUDIO SOLUTION: OVERVIEW

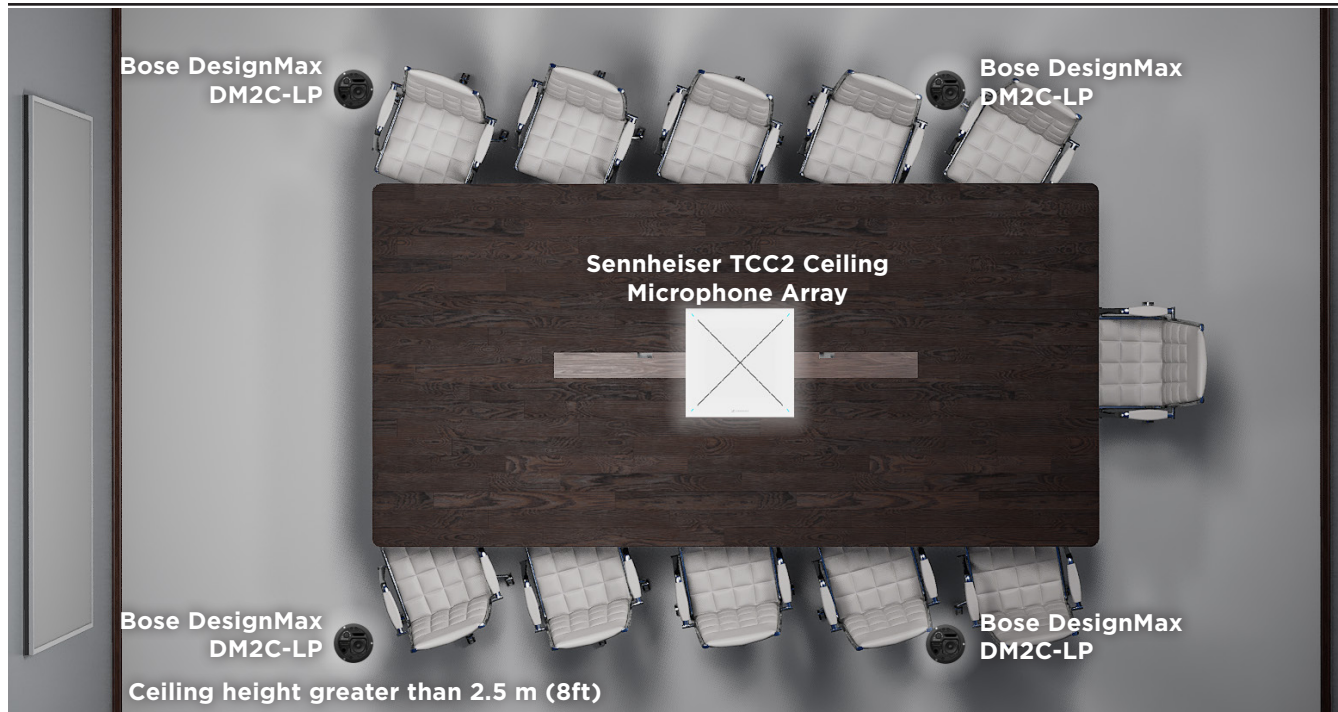

Microphone Array: The Sennheiser TeamConnect Ceiling 2 provides a patented automatic voice location detection and dynamic beamforming to capture a talker's voice no matter where they are located in the room. It quickly switches between multiple voices and it's great for rooms with flexible seating configurations.

Networked System Processor: The Bose ControlSpace EX-440C conferencing signal processor facilitates high-quality microphone integration and audio processing. Various inputs and outputs allow for flexible configuration, with four mic/line analog inputs, four analog outputs, onboard VoIP and PSTN, USB, Bose AmpLink output, eight-channel acoustic echo cancelling (AEC), and 16 x 16 Dante® connectivity.

Power Amplification: To power the four DesignMax loudspeakers, the PowerSpace P2600A provides 600 watts per channel, and the Bose AmpLink provides uncompressed, low-latency digital audio from the ControlSpace processor via a network cable.

Loudspeakers: For projects requiring premium-class, traditional ceiling loudspeakers, the Bose DesignMax DM2C-LP is the best choice. They are compact with a low-profile backcan for installation with limited above-ceiling clearance. They provide high-definition sound performance that fills the entire room for all participants

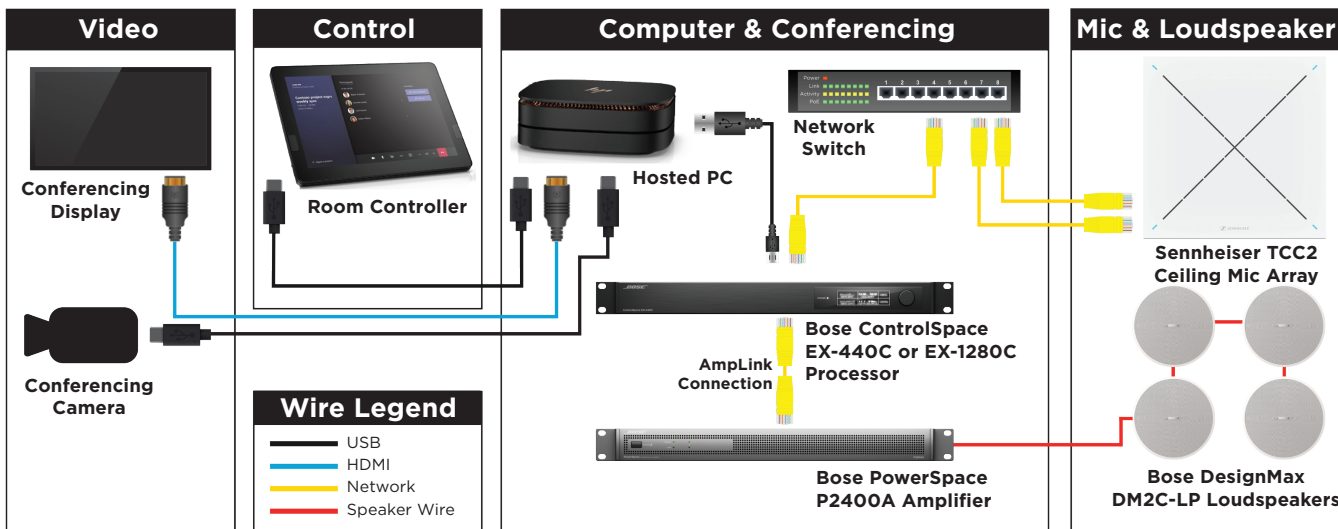

* Images not to scale



The Barco ClickShare line of products supports connectivity to the Bose Videobar™ VB1 and Bose ES1/DS4 Ceiling Audio Solutions via USB connection. All Bose Work products are certified for compatibility. This means that all audio and camera functions will be wireless passed through CX base stations to laptops. External devices such as touch screens and PTZ cameras can also be connected to CX base station over USB.

Barco ClickShare is a well-established and highly adopted wireless presentation platform in the market. The Clickshare Conference (CX) family brings wireless conferencing, a revolutionary workplace experience. It combines powerful remote communication with easy-to-use wireless collaboration, in any meeting space. A CX series solution consists of the iconic Clickshare “Buttons” and the base station, which acts a hub to aggregate all of the devices in the meeting room into a single solution.



The net result is that users are able to identify and select a single device for their room audio and camera, even if products are from multiple manufacturers.

Start a meeting from your device using your preferred conference tool. Automatically, you connect wirelessly to room cameras, speakerphones, and videobars for a more immersive meeting. In less than seven seconds, you can conference, collaborate and click with our secure, connected and cloud-managed solution.

Bring your own meeting, decide how you collaborate in any meeting space — from huddle to boardroom. Sharing with the improved ClickShare Conferencing Button and Collaboration App (PC, Mac or mobile devices) makes your meetings richer and more interactive.



Add Wireless Connectivity Between Your Computer and Bose Work System

	CX-20	CX-30	CX-50
			
Ideal for	Focus areas, meeting booths, and mobile conference carts	Huddle rooms	Medium conference rooms
Included conferencing button transmitters	1	2	2
Touch display interactivity	No	Yes	Yes
Wireless BYOM support	Yes	Yes	Yes
Concurrent connectivity	No	No	Yes
4K output resolution	Yes	Yes	Yes
Bose Videobar™ VB1 supported	Yes	Yes	Yes
Bose ES1 Ceiling Audio Solution supported	Yes	Yes	Yes
Bose DS4 Ceiling Audio Solution supported	Yes	Yes	Yes

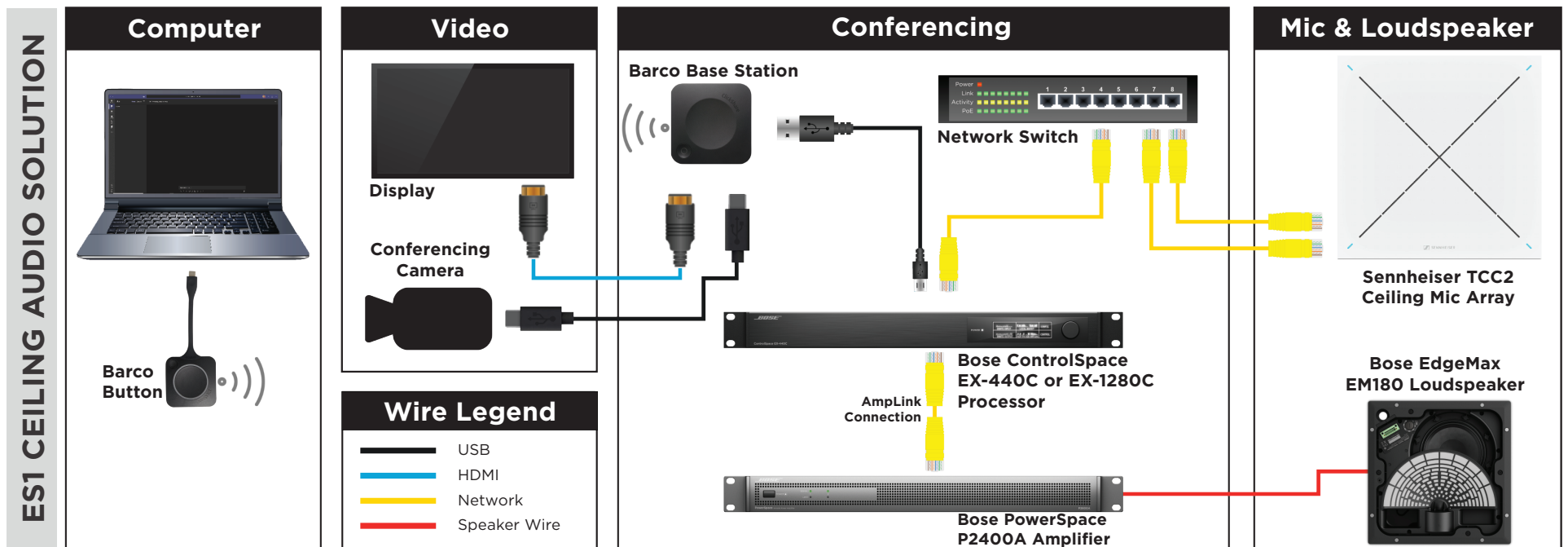
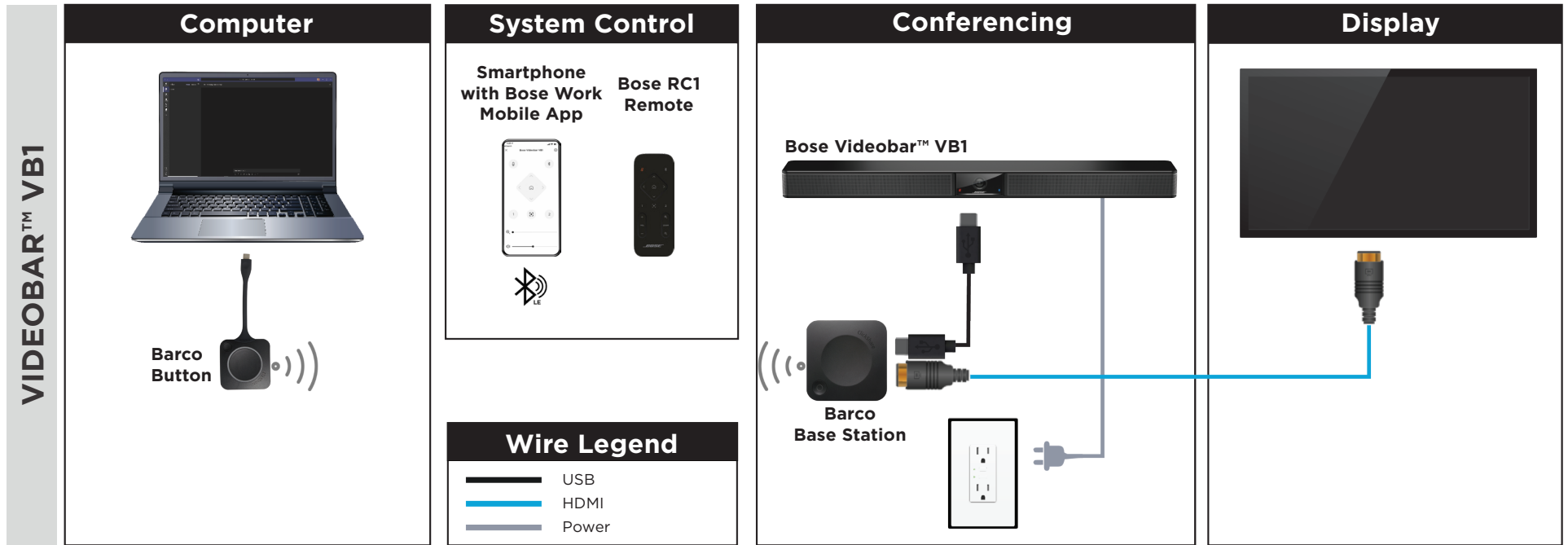

Add simplified and purpose-built meeting control and scheduling



Pictured with Videobar™ VB1

Bose Work products can be combined with the HP Elite Slice G2 Audio Ready with Microsoft Teams Rooms, or Zoom Rooms, to simplify meetings and seamlessly connect with one-touch control.

Designed for rooms of all sizes, the HP Elite Slice G2 Audio Ready features on-demand calling, dual viewing angles, and flexible accessibility. Easily add attendees and share content with one touch on the Center of Room Control using its familiar, intuitive interface.

For huddle spaces and small- to medium-sized conference rooms, the HP Elite Slice G2 Audio Ready can be combined with the Bose Videobar™ VB1 all-in-one USB conferencing device. This is an ideal solution for getting meeting rooms up and running quickly with premium audio and video from VB1 and seamless, comprehensive endpoint compute and control from the HP Elite Slice G2 Audio Ready.

The HP Elite Slice G2 Audio Ready allows for easy, flexible setup, configuration, and operation with a purpose-built conferencing endpoint with flexible mounting options and a large anti-glare Center of Room Control screen featuring one-touch capacitive controls for simple, stress-free meetings.



HP ELITE SLICE G2 AUDIO READY: SYSTEM DIAGRAM

BOSE WORK

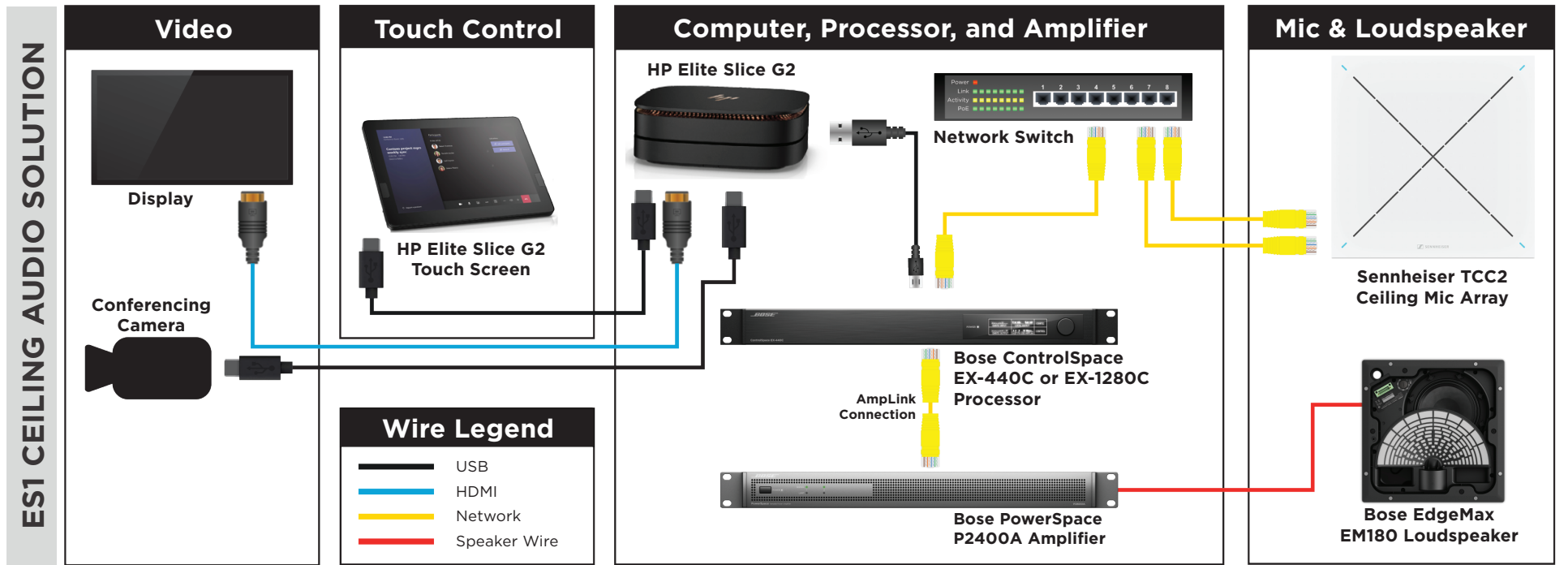
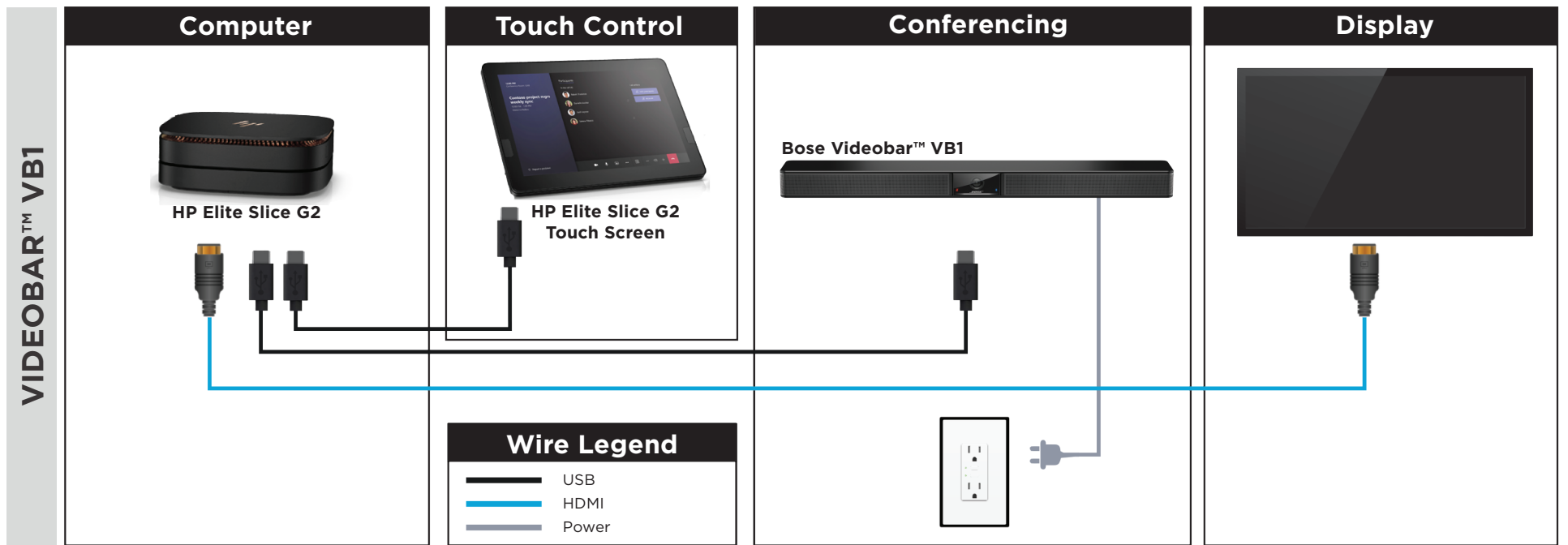

The Bose logo is centered within a white square. It consists of the word "BOSE" in a bold, italicized, sans-serif typeface. A horizontal line is positioned below the letters "B", "O", and "S", extending from the left edge of the "B" to the right edge of the "S".

BOSE

LEARN MORE AT PRO.BOSE.COM