



ControlSpace® EX

EX-UH USB/Headset Dante® Endpoint
EX-4ML 4-channel Mic/GPIO Dante® Endpoint
EX-8ML 8-channel Mic/GPIO Dante® Endpoint

Installation and Operation Guide
Guía de instalación y funcionamiento
Guide d'installation et d'utilisation
Installations- und Bedienungsanleitung
Manuale di installazione e funzionamento
Installatie- en bedieningshandleiding

Please read and keep all safety and use instructions.

This product is intended for installation by professional installers only! This document is intended to provide professional installers with basic installation and safety guidelines for this product in typical fixed-installation systems. Please read this document and all safety warnings before attempting installation.

WARNINGS:



- All Bose products must be installed in accordance with local, state, federal and industry regulations. It is the installer's responsibility to ensure installation of the product is performed in accordance with all applicable codes, including local building codes and regulations. Consult the local authority having jurisdiction before installing this product.
- To reduce the risk of fire or electrical shock, do NOT expose the product to rain, liquids, or moisture.
- Do NOT expose this apparatus to dripping or splashing, and do not place objects filled with liquids, such as vases, on or near the apparatus.
- Do NOT make unauthorized alterations to this product.
- Use this product only with an agency-approved Limited Power Source (LPS) or Class 2 Power Supply as defined in the IEC/UL60950 safety standard that meets local regulatory requirements (e.g., UL, CSA, VDE, CCC) rated 12 VDC, 5 A minimum.
- If this equipment is powered from a PoE network, the network must not originate outside of the building or exit the building at any time.
- Use only the hardware included in the package to mount this product.

Important Safety Instructions:

1. Read these instructions.
2. Keep these instructions.
3. Heed all warnings.
4. Follow all instructions.
5. Do not use this apparatus near water.
6. Clean only with a dry cloth.
7. Do not block any ventilation openings. Install in accordance with the manufacturer's instructions.
8. Do not install near any heat sources, such as radiators, heat registers, stoves, or other apparatus (including amplifiers) that produce heat.
9. Only use attachments/accessories specified by the manufacturer.
10. Unplug this apparatus during lightning storms or when unused for long periods of time.
11. Refer all servicing to qualified service personnel. Servicing is required when the apparatus has been damaged in any way, such as power-supply cord or plug is damaged, liquid has been spilled or objects have fallen into the apparatus, the apparatus has been exposed to rain or moisture, does not operate normally, or has been dropped.



This product conforms to all applicable EU directive requirements. The complete Declaration of Conformity can be found at www.Bose.com/compliance.

This Product meets all EN55103-2 immunity requirements for E2 electromagnetic environment.

Product Ratings:

EX-UH
Input Voltage: 12 V $\overline{\text{---}}$
Input Current: 400 mA

EX-4ML
Input Voltage: 12 V $\overline{\text{---}}$
Input Current: 650 mA

EX-8ML
Input Voltage: 12 V $\overline{\text{---}}$
Input Current: 1 A

Names and Contents of Toxic or Hazardous Substances or Elements

Part Name	Toxic or Hazardous Substances and Elements					
	Lead (Pb)	Mercury (Hg)	Cadmium (Cd)	Hexavalent (CR(VI))	Polybrominated Biphenyl (PBB)	Polybrominated diphenylether (PBDE)
PCBs	X	0	0	0	0	0
Metal parts	X	0	0	0	0	0
Plastic parts	0	0	0	0	0	0
Speakers	X	0	0	0	0	0
Cables	X	0	0	0	0	0

This table is prepared in accordance with the provisions of SJ/T 11364.

O: Indicates that said hazardous substance contained in all of the homogeneous materials for this part is below the limit requirement of GB/T 26572.

X: Indicates that said hazardous substance contained in at least one of the homogeneous materials used for this part is above the limit requirement of GB/T 26572.

Information About Products That Generate Electrical Noise (FCC Compliance Notice for US)

This equipment has been tested and found to comply with the limits for a Class A digital device, pursuant to part 15 of the FCC Rules. These limits are designed to provide reasonable protection against harmful interference when the equipment is operated in a commercial environment. This equipment generates, uses, and can radiate radio frequency energy and, if not installed and used in accordance with the instruction manual, may cause harmful interference to radio communications. Operation of this equipment in a residential area is likely to cause harmful interference in which case the user will be required to correct the interference at their own expense.

Changes or modifications not expressly approved by Bose Corporation could void the user's authority to operate this equipment.

This product complies with the Canadian ICES-003 Class A specifications.

CAN ICES-3(A)/NMB-3(A)



This symbol means the product must not be discarded as household waste, and should be delivered to an appropriate collection facility for recycling. Proper disposal and recycling helps protect natural resources, human health and the environment. For more information on disposal and recycling of this product, contact your local municipality, disposal service, or the shop where you bought this product.

Lea y conserve todas las instrucciones de uso y seguridad.

Este producto está diseñado para ser instalado únicamente por instaladores profesionales. Este documento está diseñado para proveer las pautas de seguridad e instalación básicas a los instaladores profesionales de este producto en sistemas de instalación fija comunes. Lea este documento y todas las advertencias de seguridad antes de comenzar la instalación.

ADVERTENCIAS:

- Todos los productos Bose deben instalarse conforme a las leyes locales, estatales, federales y del sector. Es responsabilidad del instalador asegurarse de que la instalación del producto se realice conforme a las normas legales correspondientes, incluidas las normas de construcción locales. Consulte a la autoridad local competente antes de instalar este producto.
- Para reducir el riesgo de incendio o descarga eléctrica, NO exponga el producto a la lluvia, líquidos o humedad.
- NO exponga el aparato a goteos o salpicaduras y no coloque encima ni cerca de este objetos llenos de líquido; por ejemplo, floreros.
- NO realice alteraciones no autorizadas a este producto.
- Utilice este producto solo con una fuente de alimentación limitada (LPS) aprobada por una agencia o una fuente de alimentación Clase 2, según se define en el estándar de seguridad IEC/UL60950, y que cumpla con los requisitos normativos locales (por ejemplo, UL, CSA, VDE, CCC), nominal 12 VDC, 5 A máximo.
- Si este equipo se alimenta a través de una red PoE, dicha red no debe originarse fuera del edificio ni dejar el edificio en ningún momento.
- Solo utilice el hardware incluido en el paquete para montar este producto.

Instrucciones de seguridad importantes:

1. Lea estas instrucciones.
2. Guarde estas instrucciones.
3. Preste atención a las advertencias.
4. Siga todas las instrucciones.
5. No use este aparato cerca del agua.
6. Límpielo solamente con un paño seco.
7. No obstruya ninguna abertura de ventilación. Realice la instalación conforme a las instrucciones del fabricante.
8. No lo instale cerca de ninguna fuente de calor, como radiadores, rejillas de calefacción, estufas u otros aparatos (incluidos los amplificadores) que produzcan calor.
9. Use solamente los accesorios especificados por el fabricante.
10. Desenchufe este aparato durante tormentas eléctricas o cuando no lo utilice durante períodos prolongados.
11. Derive todas las tareas de mantenimiento a personal calificado. Se requieren tareas de mantenimiento si el aparato se daña de alguna manera; por ejemplo, si se daña el enchufe o el cable de alimentación, si se derrama líquido o si caen objetos dentro del aparato, si se expone el aparato a la lluvia o la humedad, si no funciona normalmente o si se cae.



Este producto cumple con todos los requisitos correspondientes de la Directiva de la UE. La Declaración de conformidad completa puede encontrarse en www.Bose.com/compliance.

Este producto cumple con todos los requisitos de inmunidad de EN55103-2 para un entorno electromagnético E2.**Especificaciones del Producto:****EX-UH**

Voltaje de entrada: 12 V ---
Corriente de entrada: 400 mA

EX-4ML

Voltaje de entrada: 12 V ==
Corriente de entrada: 650 mA

EX-8ML

Voltaje de entrada: 12 V ===
Corriente de entrada: 1 A

Información acerca de productos que generan ruido eléctrico (aviso de cumplimiento de la FCC para EE. UU.)

Este equipo ha sido sometido a pruebas y se ha comprobado que cumple con los límites de un dispositivo digital Clase A, de acuerdo con la Parte 15 de las reglas de la FCC. Estos límites están diseñados para proporcionar una protección razonable contra interferencias perjudiciales cuando el equipo se utiliza en un entorno comercial. Este equipo genera, usa y puede irradiar energía de radiofrecuencia y, si no se instala y se usa conforme a lo indicado en el manual de instrucciones, podría causar una interferencia perjudicial a las comunicaciones de radio. El funcionamiento de este equipo en un área residencial podría llegar a provocar interferencias perjudiciales, en cuyo caso el usuario deberá corregir dichas interferencias por cuenta propia.

Los cambios o las modificaciones no aprobadas expresamente por Bose Corporation podrían invalidar la autoridad del usuario para operar el equipo.

Este producto cumple con las especificaciones Clase A de la normativa canadiense ICES-003.

CAN ICES-3(A)/NMB-3(A)



Este símbolo significa que el producto no debe desecharse como residuo doméstico y debe enviarse a una planta para tratamiento de residuos apropiada para su reciclado. Una eliminación y reciclado adecuados ayudan a proteger los recursos naturales, la salud humana y el medioambiente. Para más información acerca de la eliminación y el reciclado de este producto, comuníquese con su municipalidad local, un centro de servicios de desecho o la tienda donde compró este producto.

Merci de lire et de conserver le manuel d'instruction et de respecter les consignes de sécurité.

Ce produit doit être installé par un technicien professionnel ! Ce document est destiné à fournir aux techniciens professionnels les directives de montage et de sécurité relatives à ce produit dédié à une installation fixe. Veuillez lire ce document, ainsi que l'ensemble des avertissements de sécurité avant de procéder à l'installation.

AVERTISSEMENTS :



- Tous les produits Bose doivent être installés dans le respect des réglementations locales et nationales. Il est de la responsabilité de l'installateur professionnel de s'assurer que l'installation du produit est effectuée conformément à tous les codes applicables et dans le respect des réglementations en vigueur, y compris dans le cadre des réglementations du bâtiment où l'installation a lieu. Consultez les autorités locales compétentes avant d'installer ce produit.
- Pour limiter les risques d'incendie ou d'électrocution, n'exposez PAS l'appareil à la pluie, à toutes formes de liquides ou à l'humidité.
- Protégez l'appareil de TOUT risque de ruissellement ou d'éclaboussure. Ne placez pas d'objets contenant des liquides, tels que des vases, sur le produit ou à proximité.
- Veillez à NE PAS effectuer de modifications non autorisées sur ce produit.
- Utilisez ce produit uniquement avec une source à puissance limitée (LPS) certifiée ou une source de classe 2 comme définies dans la norme de sécurité IEC/UL60950 et conformes aux réglementations locales en vigueur (UL, CSA, VDE, CCC), évalué 12 VDC, 5 A maximum.
- Si cet équipement est branché sur un réseau PoE, ce dernier ne doit en aucun cas provenir de l'extérieur ni sortir du bâtiment.
- Utilisez uniquement le matériel inclus dans l'emballage pour monter ce produit.

Consignes de sécurité importantes :

1. Veuillez lire ces consignes.
2. Veuillez conserver ces consignes.
3. Respectez tous les avertissements.
4. Suivez toutes les consignes.
5. N'utilisez pas cet appareil à proximité d'eau ou d'une source d'humidité.
6. Utilisez uniquement un chiffon sec pour le nettoyage.
7. Ne bloquez jamais les orifices d'aération. Suivez les instructions du fabricant pour l'installation.
8. N'installez pas cet appareil à proximité d'une quelconque source de chaleur, telle qu'un radiateur, une arrivée d'air chaud, un four ou tout autre appareil (notamment les amplificateurs) produisant de la chaleur.
9. Utilisez uniquement les accessoires spécifiés par le fabricant.
10. Débranchez cet appareil pendant les orages ou au cours des longues périodes de non utilisation.
11. Confiez toute réparation à du personnel qualifié. Une réparation est nécessaire lorsque l'appareil a été endommagé de quelque façon que ce soit (endommagement du cordon d'alimentation ou de la fiche électrique, renversement d'un liquide ou de tout objet sur l'appareil, exposition de l'appareil à la pluie ou à l'humidité, mauvais fonctionnement, chute de l'appareil, etc.)



Ce produit est conforme à toutes les directives en vigueur de l'Union européenne. La déclaration de conformité complète est disponible à l'adresse www.Bose.com/compliance.

Ce produit répond aux critères d'immunité de la norme EN55103-2 pour les environnements électromagnétiques classés E2.

Spécifications du produit :

EX-UH

Tension d'entrée : 12 V ===

Courant d'entrée : 400 mA

EX-4ML

Tension d'entrée : 12 V ==

Courant d'entrée : 650 mA

EX-8ML

Tension d'entrée : 12 V ==

Courant d'entrée : 1 A

Informations sur les produits générateurs de bruit électrique (Déclaration de conformité FCC pour les États-Unis)

Ce matériel a fait l'objet de tests prouvant sa conformité aux limites imposées aux appareils numériques de classe A, conformément à la partie 15 des réglementations de la FCC. Ces limites sont conçues pour offrir une protection raisonnable contre les interférences nuisibles lorsque l'appareil est utilisé en environnement commercial. Cet appareil génère, utilise et est susceptible d'émettre de l'énergie à certaines fréquences radio. À ce titre, s'il n'est pas installé ou utilisé conformément aux instructions, il est susceptible de perturber les communications radio. L'utilisation de cet équipement dans une zone résidentielle risque de provoquer des interférences nuisibles, auquel cas l'utilisateur devra remédier au problème à ses propres frais.

Toute modification non autorisée expressément par Bose Corporation est susceptible d'annuler le droit de l'utilisateur à mettre en œuvre cet appareil.

Ce produit est conforme aux spécifications de la réglementation ICES-003 classe A du Canada.

CAN ICES-3(A)/NMB-3(A)



Ce symbole signifie que le produit ne doit pas être jeté avec les déchets ménagers, mais doit être déposé dans un centre de collecte approprié pour recyclage. La mise au rebut adéquate et le recyclage permettent de protéger les ressources naturelles, la santé humaine et l'environnement. Pour plus d'informations sur l'élimination et le recyclage de ce produit, contactez votre mairie, votre service d'enlèvement des ordures ou le magasin où vous avez acheté ce produit.

Bitte lesen Sie alle Sicherheitshinweise und Gebrauchsanleitungen durch und bewahren Sie sie auf.

Dieses Produkt darf nur von fachkundigen Monteuren installiert werden! Dieses Dokument soll fachkundigen Monteuren grundlegende Installations- und Sicherheitsrichtlinien für dieses Produkt in typischen Festinstallationsystemen bieten. Bitte lesen Sie dieses Dokument und alle Sicherheitshinweise vor der Installation durch.

WARNUNG:

- Alle Produkte von Bose müssen gemäß den örtlichen und staatlichen Vorschriften sowie gemäß allen Branchenbestimmungen verwendet werden. Der Monteur ist dafür verantwortlich, sicherzustellen, dass die Installation des Produkts gemäß allen geltenden Vorschriften durchgeführt wird, einschließlich örtlicher Bauvorschriften und Bestimmungen. Wenden Sie sich vor der Installation dieses Produkts an die zuständige abnehmende Behörde.
- Um Brände und Stromschläge zu vermeiden, darf dieses Produkt NICHT Regen, Flüssigkeiten oder Feuchtigkeit ausgesetzt werden.
- Schützen Sie das Gerät vor tropfenden oder spritzenden Flüssigkeiten, und stellen Sie keine mit Flüssigkeiten gefüllten Gefäße (z. B. Vasen) auf das Gerät oder in die Nähe des Geräts.
- Nehmen Sie KEINE nicht genehmigten Änderungen an diesem Produkt vor.
- Verwenden Sie dieses Produkt nur mit einem zugelassenen LPS-Netzteil oder einem Netzteil der Klasse 2 (gemäß den IEC/UL 60950 Sicherheitsstandards), das die lokalen gesetzlichen Anforderungen erfüllt (z. B. UL, CSA, VDE, CCC), bewertet 12 VDC, 5 A Maximal.
- Wenn dieses Gerät über ein PoE-Netzwerk betrieben wird, sollte sich dieses Netzwerk nicht außerhalb des Gebäudes befinden oder darüber hinausreichen.
- Verwenden Sie zum Montieren dieses Produkts nur die im Lieferumfang enthaltene Hardware.

Wichtige Sicherheitshinweise:

1. Lesen Sie die folgenden Anweisungen.
2. Bewahren Sie die Anweisungen auf.
3. Beachten Sie alle Warn- und Sicherheitshinweise.
4. Befolgen Sie alle Anweisungen.
5. Verwenden Sie dieses Gerät nicht in der Nähe von Wasser.
6. Reinigen Sie das Gerät nur mit einem sauberen, trockenen Tuch.
7. Achten Sie darauf, dass die Lüftungsöffnungen nicht blockiert sind. Stellen Sie das Gerät nur in Übereinstimmung mit den Herstelleranweisungen auf.
8. Stellen Sie das Gerät nicht in der Nähe von Wärmequellen auf, wie zum Beispiel Heizkörpern, Wärmespeichern, Öfen oder anderen Geräten (auch Verstärkern), die Wärme erzeugen.
9. Verwenden Sie nur Zubehör-/Anbauteile, die vom Hersteller zugelassen sind.
10. Ziehen Sie das Netzkabel bei Gewitter oder bei längerer Nichtbenutzung des Gerätes aus der Steckdose.
11. Alle Reparatur- und Wartungsarbeiten nur von qualifiziertem Kundendienstpersonal durchführen lassen. Wartungsarbeiten sind in folgenden Fällen nötig: Bei jeglichen Beschädigungen wie z. B. des Netzkabels oder Netzsteckers, wenn Flüssigkeiten oder Gegenstände in das Gehäuse gelangt sind, das Gerät Regen oder Feuchtigkeit ausgesetzt wurde, fallen gelassen wurde oder nicht ordnungsgemäß funktioniert.



Dieses Produkt entspricht allen Anforderungen der geltenden EU-Richtlinien. Die vollständige Konformitätserklärung ist einsehbar unter www.Bose.com/compliance.

Dieses Produkt erfüllt alle Immunitätsanforderungen nach EN55103-2 für elektromagnetische E2-Umgebungen.**Leistungsdaten:****EX-UH**

Eingangsspannung: 12 V ===

Eingangsstrom: 400 mA

EX-4ML

Eingangsspannung: 12 V ===

Eingangsstrom: 650 mA

EX-8ML

Eingangsspannung: 12 V ===

Eingangsstrom: 1 A

Informationen über Produkte, die elektrische Störungen verursachen (Hinweis zur FCC-Einhaltung für die USA)

Dieses Gerät wurde geprüft. Es stimmt mit den Regelungen für Geräte der Klasse A gemäß Teil 15 der FCC-Vorschriften überein. Diese Grenzwerte sollen einen angemessenen Schutz gegen elektromagnetische Störungen beim Betrieb in gewerblicher Umgebung gewährleisten. Dieses Gerät erzeugt und verwendet Hochfrequenzstrahlung und kann sie auch aussenden. Daher verursacht das Gerät, wenn die Installation und Benutzung nicht in Übereinstimmung mit dieser Bedienungsanleitung erfolgt, möglicherweise Störungen des Funkverkehrs. Beim Betrieb dieses Geräts in Wohnungen können erhebliche Störungen des Funkverkehrs verursacht werden. Eventuell daraus entstehende Kosten trägt allein der Benutzer des Geräts.

Veränderungen am Gerät, die nicht durch die Bose Corporation autorisiert wurden, können zur Folge haben, dass die Betriebserlaubnis für das Gerät erlischt.

Dieses Produkt erfüllt die kanadische Richtlinie ICES-003, Klasse A.

CAN ICES-3(A)/NMB-3(A)



Dieses Symbol bedeutet, dass das Produkt nicht mit dem Hausmüll entsorgt werden darf, sondern bei einer geeigneten Recycling-Sammelstelle abgegeben werden muss. Die ordnungsgemäße Entsorgung und das Recycling tragen dazu bei, die natürlichen Ressourcen, die Gesundheit und die Umwelt zu schützen. Weitere Informationen zur Entsorgung und zum Recycling dieses Produkts erhalten Sie von Ihrer zuständigen Kommune, Ihrem Entsorgungsdienst oder dem Geschäft, in dem Sie dieses Produkt gekauft haben.

Leggere e conservare tutte le istruzioni per la sicurezza e per l'uso.

Questo prodotto deve essere installato esclusivamente da installatori professionisti. Il presente documento ha lo scopo di fornire agli installatori professionisti le istruzioni di base per l'installazione e la sicurezza di questo prodotto in tipici sistemi da installazione fissa. Prima dell'installazione, leggere questo documento e le avvertenze sulla sicurezza.

AVVERTENZE:



- Tutti i prodotti Bose devono essere installati in conformità con gli standard locali, statali, federali e di settore. È responsabilità dell'installatore assicurare che l'installazione del prodotto sia eseguita in conformità con tutte le normative vigenti, compresi i regolamenti locali per l'integrazione degli apparati. Prima di installare il prodotto, chiedere informazioni all'autorità locale preposta.
- Per ridurre il rischio di incendio o scosse elettriche, il prodotto NON deve essere esposto a pioggia, liquidi o umidità.
- NON esporre l'apparecchio a gocce o getti di liquidi e non porre oggetti contenenti liquidi, quali ad esempio i vasi, sopra o in prossimità dell'apparecchio.
- NON apportare alterazioni non autorizzate al prodotto.
- Utilizzare il prodotto unicamente con una fonte di alimentazione limitata certificata o con un alimentatore di Classe 2 definito dallo standard di sicurezza IEC/UL60950 che soddisfa la normativa locale (ad esempio, UL, CSA, VDE, CCC), nominale 12 VDC, 5 A massimo.
- Se il prodotto è alimentato attraverso una rete PoE, quest'ultima non deve in nessun caso provenire dall'esterno dell'edificio né uscire da esso.
- Utilizzare unicamente gli accessori presenti nella confezione per il montaggio di questo prodotto.

Informazioni importanti sulla sicurezza:

1. Leggere queste istruzioni.
2. Conservare queste istruzioni.
3. Prestare attenzione a tutte le avvertenze.
4. Seguire tutte le istruzioni.
5. Non utilizzare l'apparecchio in prossimità di acqua.
6. Per la pulizia utilizzare un semplice panno asciutto.
7. Non ostruire le aperture di ventilazione. Installare il prodotto in conformità con le istruzioni fornite dal produttore.
8. Non installare i diffusori in prossimità di fonti di calore, quali termosifoni, radiatori, stufe o altri apparecchi (compresi gli amplificatori) che generino calore.
9. Utilizzare solo sistemi di fissaggio/accessori specificati dal produttore.
10. Scollegare l'apparecchio durante i temporali o quando non utilizzato per lunghi periodi di tempo.
11. Affidarsi a personale qualificato per tutti gli interventi di assistenza. Gli interventi di assistenza si rendono necessari quando l'apparecchio ha subito danni di qualsiasi tipo, ad esempio se il cavo di alimentazione o la spina sono danneggiati, se è stato versato liquido o sono caduti oggetti sull'apparecchio, se l'apparecchio è stato esposto a pioggia o umidità, se non funziona normalmente o è caduto.



Questo prodotto è conforme a tutti i requisiti pertinenti delle direttive UE. La dichiarazione di conformità completa è disponibile all'indirizzo www.Bose.com/compliance.atserklärung ist einsehbar unter www.Bose.com/compliance.

Il prodotto è conforme a tutti i requisiti di immunità EN55103-2 per ambienti elettromagnetici di tipo E2.

Specifiche di prodotto

EX-UH

Tensione di ingresso: 12 V ===

Corrente di ingresso: 400 mA

EX-4ML

Tensione di ingresso: 12 V ===

Corrente di ingresso: 650 mA

EX-8ML

Tensione di ingresso: 12 V ===

Corrente di ingresso: 1 A

Informazioni sui prodotti che generano interferenze elettriche (Conformità FCC per gli Stati Uniti)

Questa apparecchiatura è stata sottoposta a collaudo ed è risultata conforme ai limiti relativi ai dispositivi digitali di Classe A previsti dalla Parte 15 delle norme FCC. Tali limiti sono stati fissati allo scopo di assicurare un'adeguata protezione da interferenze nocive quando l'apparecchiatura è utilizzata in un'installazione commerciale. Questa apparecchiatura genera, utilizza e può irradiare energia a radiofrequenza e, se non installata e utilizzata in conformità con il manuale di istruzioni, può causare interferenze con le locali comunicazioni radiofoniche. L'utilizzo di questa apparecchiatura in un'area residenziale può provocare interferenze nocive, nel qual caso l'utente dovrà adottare misure correttive a proprie spese. Eventuali modifiche o alterazioni non espressamente approvate da Bose Corporation possono rendere nulla l'autorizzazione dell'utente all'utilizzo dell'apparecchiatura stessa.

Questo prodotto è conforme alle specifiche canadesi ICES-003 di Classe A.

CAN ICES-3(A)/NMB-3(A)



Questo simbolo indica che il prodotto non deve essere smaltito come rifiuto domestico, ma deve essere consegnato a una struttura di raccolta appropriata per il riciclaggio. Uno smaltimento e un riciclaggio corretti aiutano a preservare le risorse naturali, la salute e l'ambiente. Per ulteriori informazioni sullo smaltimento e sul riciclaggio di questo prodotto, rivolgersi alle autorità locali, al servizio di smaltimento dei rifiuti o al negozio presso il quale è stato acquistato.

Lees alle veiligheidsinstructies en de gebruiksaanwijzing door en bewaar deze.

Dit product is uitsluitend bestemd voor installatie door professionele installateurs! Dit document is bedoeld om professionele installateurs essentiële installatie- en veiligheidsrichtlijnen te bieden voor dit product in standaardssystemen voor vaste installatie. Lees dit document en alle veiligheidsaanschuivingen voordat u een systeem probeert te installeren.

WAARSCHUWINGEN:

- Alle Bose-producten moeten worden geïnstalleerd volgens de plaatselijke en landelijke voorschriften en industriënormen. Het is de verantwoordelijkheid van de installateur om ervoor te zorgen dat de installatie van het product wordt uitgevoerd volgens alle van toepassing zijnde voorschriften, inclusief plaatselijke bouwvoorschriften. Neem contact op met de juiste plaatselijke overheidsinstanties voordat u dit product installeert.
- Om het risico op brand of elektrische schokken te verlagen, mag het product NIET worden blootgesteld aan regen, vloeistof of vocht.
- Stel dit apparaat NIET bloot aan druppende of spattende vloeistoffen en plaats geen met vloeistof gevulde voorwerpen, zoals vazen, op of bij het apparaat.
- Er mogen GEEN wijzigingen aan dit product worden aangebracht door onbevoegden.
- Gebruik dit product uitsluitend met een officieel goedgekeurde Limited Power Source (LPS) of een voeding van klasse 2, zoals gedefinieerd in de veiligheidsnorm IEC/UL60950 die voldoet aan de lokale voorschriften (bijv. UL, CSA, VDE, CCC), beoordeeld 12 VDC, 5 een maximum.
- Als dit apparaat wordt aangesloten op een PoE-netwerk, mag het netwerk nooit van buiten het gebouw komen of het gebouw verlaten.
- Gebruik alleen de hardware in het pakket om dit product te monteren.

Belangrijke veiligheidsinstructies:

1. Lees deze instructies door.
2. Bewaar deze instructies.
3. Neem alle waarschuwingen in acht.
4. Volg alle instructies.
5. Gebruik dit apparaat niet in de buurt van water.
6. Alleen met een droge doek reinigen.
7. Zorg dat u de ventilatieopeningen niet blokkeert. Installeer het apparaat volgens de instructies van de fabrikant.
8. Installeer het product niet in de buurt van warmtebronnen, zoals radiatoren, warmterosters, kachels of andere apparaten (waaronder versterkers) die warmte produceren.
9. Gebruik uitsluitend aansluitstukken/accessoires die door de fabrikant worden gespecificeerd.
10. Haal de stekker van dit apparaat uit het stopcontact bij onweer of als het langere tijd niet wordt gebruikt.
11. Laat alle reparaties en onderhoud over aan bevoegde servicemedewerkers. Onderhoud is vereist als het apparaat is beschadigd, als bijvoorbeeld een elektriciteitsnoer of stekker is beschadigd, als er vloeistof in het apparaat is gemorst of voorwerpen in het apparaat zijn gevallen, als het apparaat is blootgesteld aan regen of vocht, of als het niet normaal werkt of is gevallen.



Dit product voldoet aan alle vereisten van de van toepassing zijnde EU-richtlijnen. De volledige conformiteitsverklaring kunt u vinden op www.Bose.com/compliance.

Dit product voldoet aan alle immuniteitsvereisten van EN55103-2 voor een E2 elektromagnetische omgeving.

Productvermogen:**EX-UH**

Ingangsspanning: 12 V \equiv

Ingangsstroom: 400 mA

EX-4ML

Ingangsspanning: 12 V \equiv

Ingangsstroom: 650 mA

EX-8ML

Ingangsspanning: 12 V \equiv

Ingangsstroom: 1 A

Informatie over producten die elektrische ruis genereren (FCC Compliance Notice voor de VS)

Dit apparaat is getest en voldoet aan de limieten voor een digitaal apparaat van de klasse A, volgens deel 15 van de FCC-voorschriften. Deze limieten zijn bedoeld om redelijke bescherming te bieden tegen schadelijke storing bij installatie in een handelsomgeving. Dit apparaat genereert en gebruikt radiofrequentie energie en kan deze uitstralen en het kan, als het niet wordt geïnstalleerd en gebruikt volgens de instructies, schadelijke storing veroorzaken aan radiocommunicatie. Gebruik van dit apparaat in een woonwijk kan schadelijke storing veroorzaken. In dit geval moet de gebruiker de storing op eigen kosten verhelpen.

Veranderingen of aanpassingen die niet uitdrukkelijk zijn goedgekeurd door Bose Corporation kunnen leiden tot het vervallen van de bevoegdheid van de gebruiker om dit apparaat te gebruiken.

Dit product voldoet aan de specificaties van de Canadese ICES-003 klasse A.

CAN ICES-3(A)/NMB-3(A)



Dit symbool betekent dat het product niet mag worden weggegooid als huishoudelijk afval en naar een geschikt inzamelpunt voor recycling moet worden gebracht. Het op de juiste wijze afvoeren en recyclen helpt natuurlijke hulpbronnen, de menselijke gezondheid en het milieu te beschermen. Voor meer informatie over het afvoeren en recyclen van dit product neemt u contact op met de gemeente waar u woont, de afvalverwerkingsdienst of de winkel waar u dit product hebt gekocht.

Product Overview

Thank you for purchasing a Bose® ControlSpace® EX Dante® endpoint. Each endpoint provides an audio interface for using Dante, a digital media networking technology from Audinate®.

ControlSpace EX Dante endpoints are available in three models: EX-UH (USB/headset), EX-4ML (4-channel mic/GPIO), and EX-8ML (8-channel mic/GPIO).

Package Contents

Each carton contains one ControlSpace EX Dante endpoint device, one (1) RJ-45 ethernet cable, four (4) installation screws, a screw placement template, cable ties, and an installation guide. In addition:

- The EX-UH package contains an RJ-9 cable, a USB-to-microUSB cable, and two (2) black Euroblock connectors (2-pin).
- The EX-4ML package contains four (4) green Euroblock connectors (7-pin), and two (2) black Euroblock connectors (2-pin).
- The EX-8ML package contains eight (8) green Euroblock connectors (7-pin), and two (2) black Euroblock connectors (2-pin).

Optional accessories are available separately:

- EX Mounting Bracket (PN 790080).
- EX Microphone Extension Cable (PN 790081).
- EX Endpoint Power Supply (PN 800446)

Limited Warranty

Your product is covered by a limited warranty, Visit **pro.Bose.com** for warranty details.

The warranty information provided with this product does not apply in Australian and New Zealand. See our website at **www.bose.com/au/warranty** or **www.bose.com/nz/warranty** for details of the Australian and New Zealand warranty.

Audinate® and Dante® is a trademark of Audinate Pty Ltd.

All other trademarks are the property of their respective owners.

Refer to the owner's guide (online) for more information about this product, including accessories and replacement parts. To request a printed copy, use the phone numbers provided.

Date of Manufacture: The eighth digit in the serial number indicates the year of manufacture; "7" is 2007 or 2017.

Mounting Instructions

The EX endpoints can be mounted using one of three methods: Mounting wing brackets as shipped (outside mount), mounting wing brackets rotated 180 degrees (inside mount), mounting using the optional EX Mounting Bracket (PN 790080).

NOTE: Use only the hardware included in the package to mount this product.

Mount with Wing Brackets Out

To mount the endpoints with wing brackets out:

1. Use “outside mount” hole locations on enclosed template to mark mounting surface with location of screw holes.
2. Install supplied screws. Leave sufficient space between screw head and mounting surface to accommodate the thickness of the wing bracket.
3. Position endpoint on screws at wing bracket center holes. Slide endpoint forward or backward to lock in position.
4. Tighten screws.

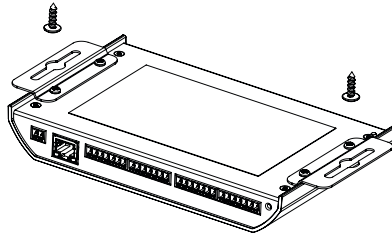

Mount with Wing Brackets In

Use this option when there is insufficient space to mount with the wing brackets out. To mount the endpoints with wing brackets in:

1. Remove the four screws (two on each side) that attach the wing brackets to the endpoint.
2. Rotate wing brackets as shows in figure. Re-install the wing brackets onto the endpoint by replacing the four screws.
3. Use “inside mount” hole locations marked on enclosed template to mark mounting surface with location of screw holes.
4. Install supplied screws. Leave sufficient space between screw head and mounting surface to accommodate the thickness of the wing bracket.
5. Position endpoint on screws at wing bracket center holes. Slide endpoint forward or backward to lock in position.

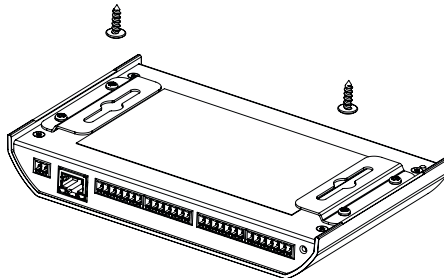

Mount Using EX Mounting Bracket

Install the Mounting Bracket

To mount the endpoints using the optional EX Mounting Bracket Accessory (PN 790080)::

1. Use the included template to mark the correct drilling locations on the mounting surface.
2. Attach the mounting bracket to the surface using the screws included in the EX Mounting Bracket Accessory kit.

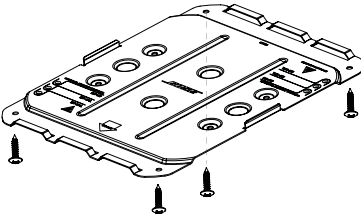

3. Remove the wing brackets attached to the endpoint by removing the two (2) screws that attach each wing brackets to the endpoint.

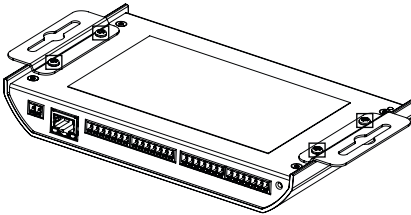

4. Place the endpoint against the installed mounting bracket. The endpoint adheres to the mounting bracket magnetically.

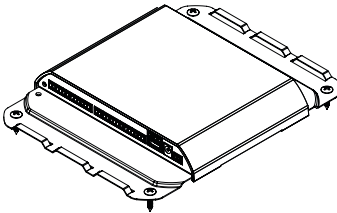

Install the L-Shaped Retention Brackets

Use the optional L-shaped mechanical retention brackets with the EX Mounting Bracket Accessory to provide additional connection points between the endpoint and the mounting bracket.

To mount the endpoint using the L-shaped retention brackets:

1. Attach the L-shaped retention brackets to the endpoint, using the enclosed screws. Attach one bracket to each side of the endpoint (front and rear), in opposite corners.
2. Position the endpoint on the installed mounting bracket.
3. Attach the L-shaped retention brackets to the mounting bracket, using the screws included in the EX Mounting Bracket Accessory kit.

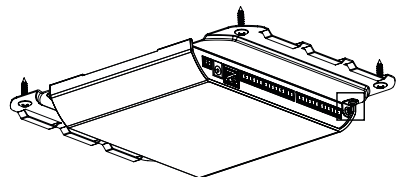
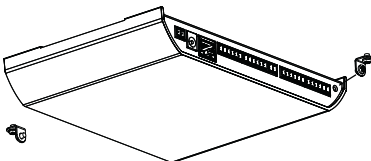

Front and Rear Panels

EX-UH USB/Headset Endpoint

EX-UH Front View

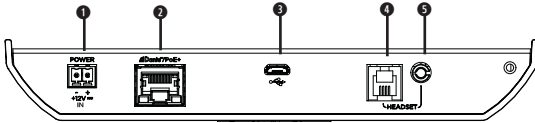

EX-UH Rear View

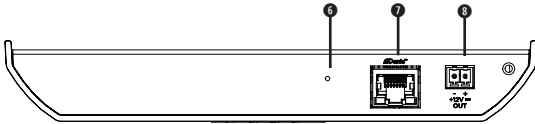

- 1 +12 V DC in
- 2 Dante/PoE+ in
- 3 USB (MicroUSB)
- 4 RJ-9 telephone headset in/out
- 5 3.5 mm TRRS analog in/out
- 6 Reset button
- 7 Dante out
- 8 +12 V DC out

EX-4ML 4-Channel Mic/GPIO Endpoint

EX-4ML Front View

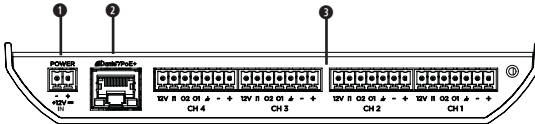

EX-4ML Rear View



- 1 +12 V DC in
- 2 Dante/PoE+ in
- 3 Analog audio in/GPIO (channels 1-4)
- 4 Reset button
- 5 Dante out
- 6 +12 V DC out

EX-8ML 8-Channel Mic/GPIO Endpoint

EX-8ML Front View

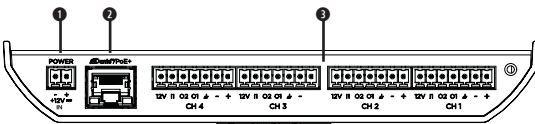

EX-8ML Rear View

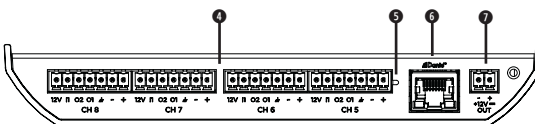

- 1 +12 V DC in
- 2 Dante/PoE+ in
- 3 Analog audio in/GPIO (channels 1-4)
- 4 Analog audio in/GPIO (channels 5-8)
- 5 Reset button
- 6 Dante out
- 7 +12 V DC out

Connecting and Powering

The endpoints can be powered using Power-over-Ethernet (PoE+) or the optional external 12 V DC power supply.

Note: Make all network and audio connections to the endpoint before the power is applied.

Powering Using PoE+

Use PoE+ to connect a single endpoint, or to daisy-chain a maximum of three (3) endpoints:

1. Connect a PoE+ enabled port on the Dante network switch to the **Dante/PoE+** network port on the first endpoint in the chain, using a CAT 5 cable.
2. To connect additional endpoints, follow the instructions below for Connecting Multiple Endpoints.

To daisy-chain more than three endpoints, use an external power supply instead of PoE+.

Note: When determining the number of ControlSpace EX endpoints that can be daisy-chained for power, you must consider total power consumption. Add the power of each endpoint (6 watts each) and all connected microphones. Microphones typically consume phantom power as well as LED power (if applicable). Bose maintains a knowledgebase article at <http://bosepro.link/micpower> that provides total power information for popular conferencing microphones. The total value must not exceed (with some margin) the power source capacity. When using PoE as a source, do not exceed 12 watts in the chain. With PoE+, the total power must not exceed 24 watts. If you exceed the total power available on one PoE/PoE+ cable, consider running a second CAT 5 cable, or use a Bose accessory power supply.

Powering Using Optional External Power Supply

Use the optional EX Endpoint Power Supply or a 12 V DC Limited Power Source (LPS) or Class 2 Power Supply (as defined in the IEC60065/UL60950 safety standard) to daisy-chain a maximum of six (6) endpoints:

1. Connect a port on the Dante network switch to the **Dante/PoE+** network port on the endpoint, using a CAT 5 cable.
2. To connect additional endpoints, follow the instructions below for Connecting Multiple Endpoints.
3. Connect the power supply to **+12 V DC IN** on the first endpoint in the chain.

Connecting Multiple Endpoints

Daisy-chain a maximum of three (3) endpoints using PoE+, or up to six (6) endpoints using an external power supply.

To connect multiple endpoints:

1. Connect a port on the Dante network switch to the **Dante/PoE+** port on the first endpoint in the chain using a CAT 5 cable. If you are using PoE+ to power the endpoints, connect to a PoE+ enabled port on the Dante network switch.
2. Connect the Dante port on the first endpoint to the Dante/PoE+ port on the second endpoint, using a CAT 5 cable. If you are not using PoE+ to power the endpoints, connect an external power supply to the first endpoint.
3. Connect the +12 V DC OUT on the first endpoint to the +12 V DC IN on the second endpoint. Terminate each end of this cable using the included 2-pin Euroblock connectors.

Repeat steps 2 and 3 for each additional endpoint.

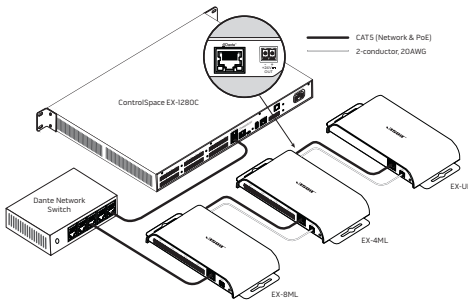

Network Configuration

Network Connections

Each EX Dante Endpoint has two (2) Dante ports, which facilitates daisy-chaining: Additional endpoints can be connected to the first, eliminating the need for additional home-runs. Note that PoE+ power is not daisy-chained; therefore, when daisy-chaining, the additional devices must be powered either by connecting to the previous devices' **+12 V DC OUT** or by using the optional EX Endpoint Power Supply accessory.

The two Dante ports on each endpoint are connected via an internal Ethernet switch. Therefore, either one can be used to provide the Dante connection. However, if PoE+ is used to power the endpoint, then the cable must be connected to the **Dante/PoE+** port.

Network Communications

EX-UH

The EX-UH has two (2) USB inputs (USB L, USB R) and two (2) analog inputs (Hset L, Hset R). It also has two (2) USB outputs (USB L, USB R) and one (1) analog output (Hset Mic). The USB and analog IO are transmitted or received over Dante; thus, the EX-UH appears as a 4-input, 3-output device in the Bose ControlSpace Designer software and the Dante controller software. ControlSpace Designer supports "Auto Dante Programming" for the EX-UH, eliminating the need to use the PC to configure the audio routing.

When an EX-UH is added to a design, and then to a particular DSP, it will show up as "Dante Audio Routes" for that DSP (4 Rx ch and 3 Tx ch):

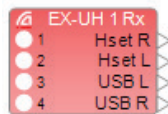

EX-4ML and EX-8ML

The EX-4ML and EX-8ML convert 4 or 8 analog audio channels to Dante channels. They appear as 4- or 8-channel Dante transmitters in ControlSpace Designer or Dante Controller software, respectively. They also convert 4 or 8 control inputs to networked messages.

These networked GPI can be used within ControlSpace Designer to drive other logic states, or can be accessed using the ControlSpace API, Crestron Drivers, or AMX drivers. The EX-4ML and EX-8ML support "Auto Dante Programming" eliminating the need to use PC to configure the audio routing. When an EX-4ML or EX-8ML is added to the design, they will show up as "Dante Audio Routes" for that DSP:

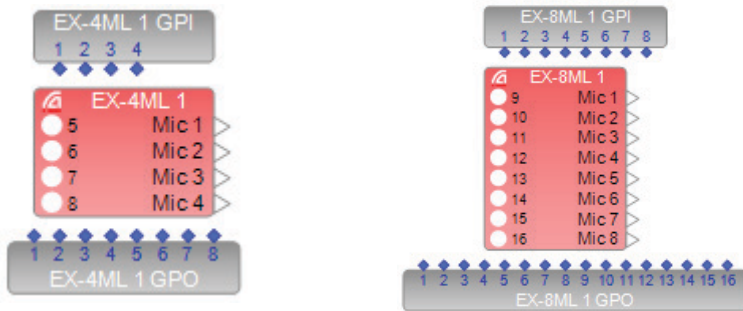

IP Address

To set up the internal parameters and audio routing, the PC must be able to communicate with the endpoint over the network. While all Dante devices will be discovered regardless of the IP address setup on the PC, communication can only occur if the PC and the device have compatible IP addresses.

If the IP addresses are configured incorrectly, the device will not authenticate in the ControlSpace Designer software. The input and output channels will not be visible, and routing of audio to and from the device will not be possible.

By default, the device is set to DHCP. If a DHCP server is found, the device will request an IP address. If no DHCP server is found, the device will use Auto IP (Automatic Private IP Addressing) to assign itself an address. The device can be set to a static IP address using Audinate's Dante Controller software or Bose's ControlSpace Designer software, assuming the PC IP address is on the same subnet.

If a static IP address is set and then lost, such that ControlSpace Designer no longer connects to the device, press and hold the reset button for five seconds to restore the factory default IP settings. This allows the device to obtain a new IP address using DHCP, so it can be configured again using ControlSpace Designer.

Alternatively, use the Dante Controller software or an IP discovery tool to locate the device, then change the PC's IP address to match the device's subnet and change the device's address as needed.

Audio Connections

EX-UH Connections

The EX-UH allows you to use a telephone handset, cell phone, or PC to connect a call. The EX-UH supports both analog and USB audio connections to cellphones/PCs.

Telephone Handset Connection

To connect to a call using a telephone handset, connect the headset jack on the telephone handset to the RJ-9 **HEADSET** connection on the EX-UH endpoint, using the included RJ-9 cable.

Using the EX-UH with a telephone handset

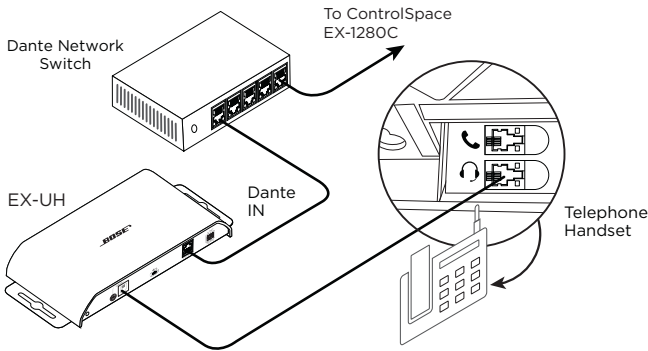

Analog Audio Cellular Phone/PC Connection

To connect a call using a cellular phone or PC, connect the 3.5 mm headset jack on the cellular telephone or PC to the 3.5 mm TRRS **HEADSET** connection on the EX-UH endpoint.

Using the EX-UH with a telephone or PC equipped with a 3.5 mm TRRS jack

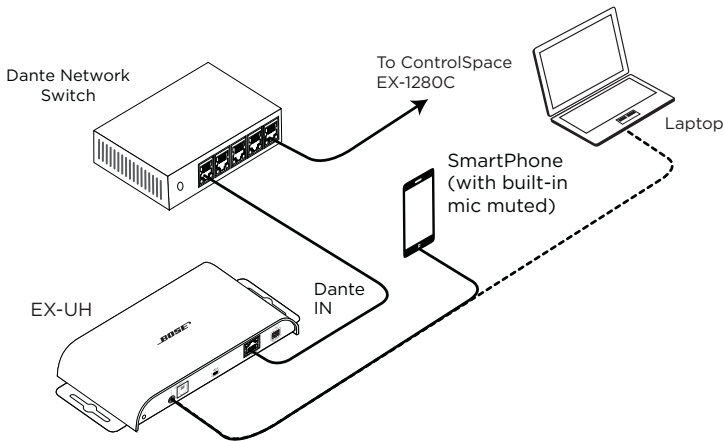

USB Audio Cellphone/PC Connection

Use the supplied USB cable (USB micro to USB A), or a cable appropriate to your device, to connect the USB port on the EX-UH to a PC or cellphone.

Using the EX-UH with a telephone or PC equipped with a USB port

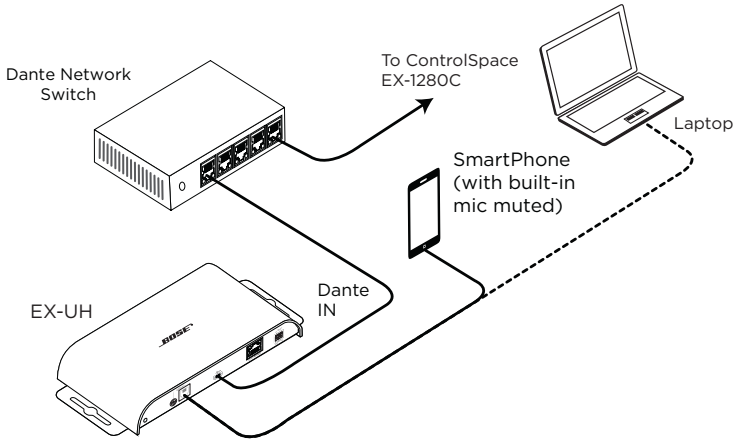

EX-UH Wiring Diagram

The EX-UH converts USB and analog audio to and from Dante. Both analog and USB connections are supported simultaneously. However, since analog connections are connected internally, only one analog connection (either the RJ-9 headset connection or the TRRS cellphone/PC connection) is supported at any one time.

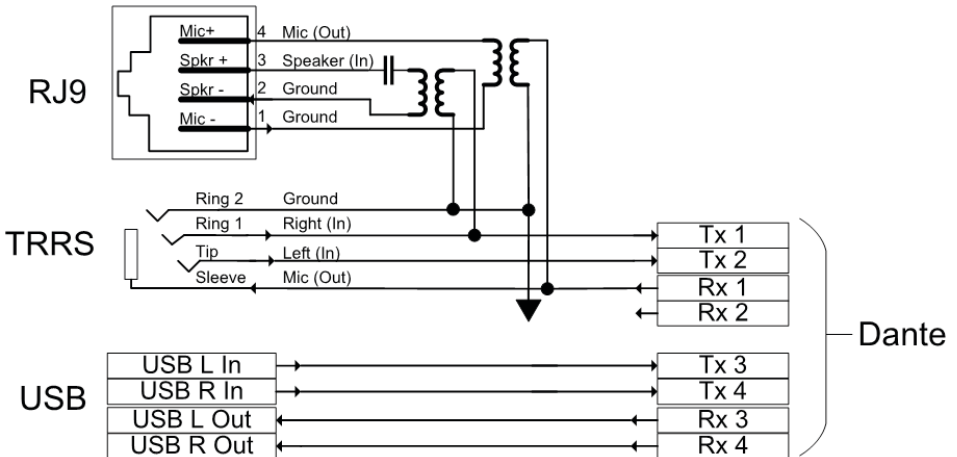

EX-4ML and EX-8ML Connections

Audio Wiring

The EX-4ML and EX-8ML endpoints include four (4) or eight (8) balanced, mic/line analog audio inputs, respectively. Connect devices to these inputs using the included 3.81 mm, 7-pin Euroblock connectors.

Control Wiring

Each analog audio input includes control connections for two general purpose outputs (GPO) and one general purpose input (GPI). The GPIO are compatible with most microphones that use LEDs or LED rings and integrated push buttons.

The EX-4ML and EX-8ML also include 12 V microphone power output on each audio connector, which can power microphones with LEDs and eliminate the need for an external power supply.

Microphones can be wired directly by following the wiring diagrams shown below. For some microphones, an accessory adapter may be available to simplify the wiring.

NOTE: The following diagrams are provided for convenience, but are subject to change. Please review wiring information from the microphone manufacturer for the most up-to-date information.

Shure MX41x

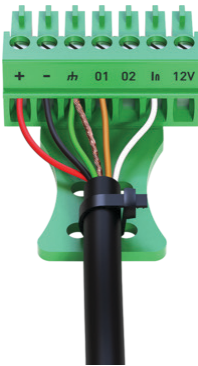

Mic Signal	Mic Wire Color	Function	EX UTB Connector Pin
Audio +	Red	Audio +	+
Audio -	Black	Audio -	-
Shield	Bare	Shield	sh
Logic Ground	Green	Ground	01
Switch Out	White	Switch	02
LED In	Orange	LED	1a

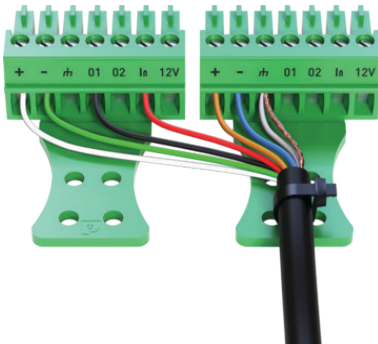

Shure MX396/Dual

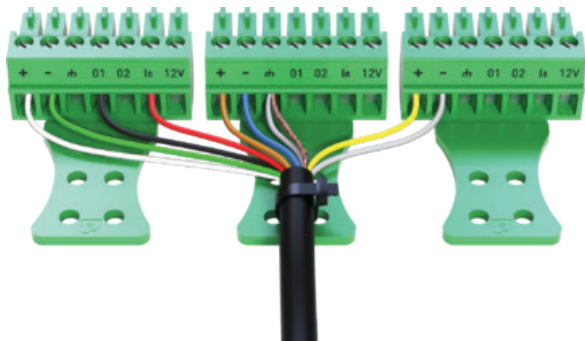

Mic Signal	Mic Wire Color	Function	EX UTB Connector Pin
Mic 1 Audio +	White	Audio +	Ch 1 +
Mic 1 Audio -	Green	Audio -	Ch 1 -
Mic 2 Audio +	Orange	Audio +	Ch 2 +
Mic 2 Audio -	Blue	Audio -	Ch 2 -
Shield	Bare	Shield	sh
Logic Ground	Silver	Ground	01
Switch Out	Red	Switch	Ch 1 02
LED In	Black	LED	Ch 1 1a

Shure MX396 Tri-Element



Mic Signal	Mic Wire Color	Function	EX UTB Connector Pin
Mic 1 Audio +	White	Audio +	Ch 1 +
Mic 1 Audio -	Green	Audio -	Ch 1 -
Mic 2 Audio +	Orange	Audio +	Ch 2 +
Mic 2 Audio -	Blue	Audio -	Ch 2 -
Mic 3 Audio +	Yellow	Audio +	Ch 3 +
Mic 3 Audio -	Gray	Audio -	Ch 3 -
Shield	Bare	Shield	
Logic Ground	Silver	Ground	
Switch Out	Red	Switch	Ch 1 I1
LED In	Black	LED	Ch 1 O1

Clock Audio CS 1S



Mic Signal	Mic Wire Color	Function	CAT 5 Pin	CAT 5 Color	EX UTB Connector Pin
Mic 1 Audio +	Red	Audio +			Ch 1 +
Mic 1 Audio -	Black or White	Audio -			Ch 1 -
Shield	Bare	Shield			
Logic Ground	Blue	Ground	3	White/Green	
Switch Out	Yellow	Switch	5	White/Blue	Ch 1 I1
Red LED In	Red	Red LED	2	Orange	Ch 1 O1
Green LED In	Green	Green LED	6	Green	Ch 1 O2
+12 V	Brown	LED Power	4	Blue	+12 V

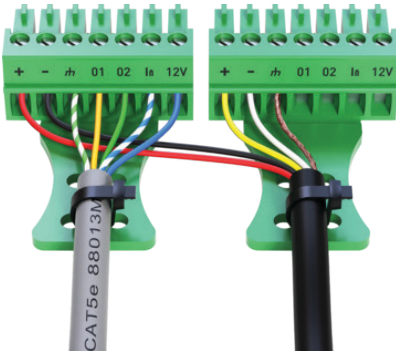

Clock Audio CS 2S

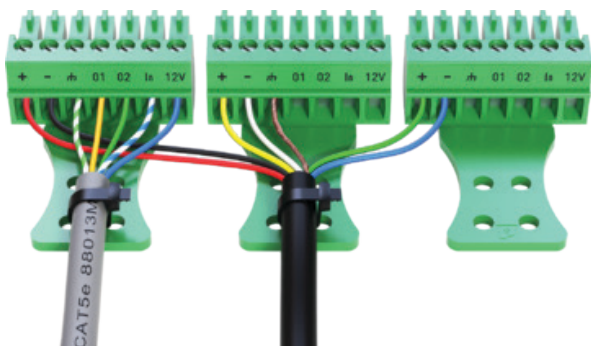

Mic Signal	Mic Wire Color	Function	CAT 5 Pin	CAT 5 Color	EX UTB Connector Pin
Mic 1 Audio +	Red	Audio +			Ch 1 +
Mic 1 Audio -	Black	Audio -			Ch 1 -
Mic 2 Audio +	Yellow	Audio +			Ch 2 +
Mic 2 Audio -	White	Audio -			Ch 2 -
Shield	Bare	Shield			
Logic Ground	Blue	Ground	3	White/Green	
Switch Out	Yellow	Switch	5	White/Blue	Ch 1 I1
Red LED In	Red	Red LED	2	Orange	Ch 1 O1
Green LED In	Green	Green LED	6	Green	Ch 1 O2
+12 V	Brown	LED Power	4	Blue	+12 V

Clock Audio CS 3S-RF



Mic Signal	Mic Wire Color	Function	CAT 5 Pin	CAT 5 Color	EX UTB Connector Pin
Mic 1 Audio +	Red	Audio +			Ch 1 +
Mic 1 Audio -	Black	Audio -			Ch 1 -
Mic 2 Audio +	Yellow	Audio +			Ch 2 +
Mic 2 Audio -	White	Audio -			Ch 2 -
Mic 3 Audio +	Green	Audio +			Ch 3 +
Mic 3 Audio -	Blue	Audio -			Ch 3 -
Shield	Bare	Shield			
Logic Ground	Blue	Ground	3	White/Green	
Switch Out	Yellow	Switch	5	White/Blue	Ch 1 I1
Red LED In	Red	Red LED	2	Orange	Ch 1 O1
Green LED In	Green	Green LED	6	Green	Ch 1 O2
+12 V	Brown	LED Power	4	Blue	+12 V

Audio Technica ES947 Microphone and AE8657/LED Mount



Mic Signal	Mic XLR Pin	Function	EX UTB Connector Pin
Audio +	Pin 2	Audio +	Ch 1 +
Audio -	Pin 3	Audio -	Ch 1 -
Shield	Pin 1	Shield	
Switch Out	Pin 4	Switch	Ch 1 II
LED In	Pin 5	Red LED	Ch 1 O1

Earthworks IMBL30



Mic Signal	Mic Wire Color	Function	Euroblock Pin	CAT 5 Pin	CAT 5 Color	EX UTB Connector Pin
Mic 1 Audio +	Red	Audio +				Ch 1 +
Mic 1 Audio -	Black	Audio -				Ch 1 -
Shield	Bare	Shield				
Logic Ground	Blue	Ground	1	4, 5	Blue	
Switch Out	Yellow	Switch	3	6	Green	Ch 1 II
Red LED In	Red	Red LED	4	7, 8	Brown	Ch 1 O1
Green LED In	Green	Green LED	5	1, 2	Orange	Ch 1 O2
+12 V	Brown	LED Power	2	3	White/ Green	+12 V

Technical Specifications

Audio Inputs	
Input Channels	EX-UH: RJ-9 mic/speaker headset jack; 3.5 mm TTRS unbalanced stereo input/microphone jack; Type B/Device USB
	EX-4ML: Four (4) analog, balanced microphone/line level 3.81 mm Euroblock connectors, 7-pin
	EX-8ML: Eight (8) analog, balanced microphone/line level 3.81 mm Euroblock connectors, 7-pin
DC Power Out	+12 V DC
Phantom Power	48 V DC, software selectable per input (EX-4ML and EX-8ML only)
Gain Settings	0/+15/+30/+45 dB, software selectable (EX-4ML and EX-8ML only)
Input Impedance	> 8 kΩ at any gain setting (EX-4ML and EX-8ML only)
Equivalent Input Noise	-115 dBu (+45 dB gain) (EX-4ML and EX-8ML only)
Maximum Input Level	12 dBu @ 0 dB gain (EX-4ML and EX-8ML only)
Control Input/Output	
+12 V DC	100 mA
Output 1, 2	Sink: 1 V, 100 mA; Source: 4 V, 10 mA
Input 1	0 - 5 V, 5K Pullup to 3.3 V (Switching level high > 0.7, low < 0.3)
Software Application	
ControlSpace Designer Software version 5.0 or later	
General	
DC Power In	+12 V DC ; 400 mA (EX-UH) / 650 mA (EX-4ML) / 1 A (EX-8ML)
Digital Conversion	48 kHz, 24-bit
System THD	< 0.01% at any gain, input signal 3 dB below maximum
PoE Class	Class 0 802.3af or 802.3 at PoE PD compliant
Certifications	FCC Part 15 Class A, CE (EN55022 Class A), IEC 60950-1 (ed.2); am1, am2; UL 60950-1 (ed.2) and CAN/CSA C22.2 No. 60950-1-07 (ed.2), 2014-10
Dimensions (W x L x H)	EX-UH: 176 x 206 x 27 mm (6.9 x 8.1 x 1.1 inches)
	EX-4ML: 196 x 206 x 27 mm (7.7 x 8.1 x 1.1 inches)
	EX-8ML: 216 x 206 x 27 mm (8.5 x 8.1 x 1.1 inches)
Operating Temperature	0 °C - 40 °C (32 °F - 104 °F)
Product Code	EX-UH: 771784-0110
	EX-4ML: 771783-0110
	EX-8ML: 772045-0110

Contact Information

Visit us on the web at pro.Bose.com.

Americas

(USA, Canada, Mexico, Central America, South America)

Bose Corporation
The Mountain
Framingham, MA 01701 USA
Corporate Center: 508-879-7330
Americas Professional Systems,
Technical Support: 800-994-2673

Australia

Bose Pty Limited
Unit 3/2 Holker Street
Newington NSW Australia
TEL 61 2 8737 9999

Belgium

Bose N.V. / S.A
Limesweg 2, 03700
Tongeren, Belgium
TEL (32) 012-390800

China

Bose Electronics (Shanghai) Co Ltd
36F, West Gate Tower
1038 West Nanjing Road
Shanghai, P.R.C. 200041 China
TEL 86 21 6271 3800

France

Bose S.A.S
26-28 avenue de Winchester
78100 St. Germain en Laye, France
TEL 01-30-61-63-63

Germany

Bose GmbH
Max-Planck Strasse 36D 61381
Friedrichsdorf, Deutschland
TEL 06172-7104-0

Hong Kong

Bose Limited
Suites 2101-2105, Tower One, Times Square
1 Matheson Street, Causeway Bay, Hong Kong
TEL 852 2123 9000

India

Bose Corporation India Private Limited
Salcon Aurum, 3rd Floor
Plot No. 4, Jasola District Centre
New Delhi - 110025, India
TEL 91 11 43080200

Italy

Bose SpA
Centro Leoni A - Via G. Spadolini
5 20122 Milano, Italy
TEL 39-02-36704500

Japan

Bose Kabushiki Kaisha
Shibuya YT Building
28-3 Maruyama-sho
Shibuya-Ku, Tokyo, 150, Japan
TEL 81-3-5489-0955
www.bose.co.jp

The Netherlands

Bose BV
Gorslaan 60, 1441 RG
Purmerend, Nederland
TEL 31 (0)299-390139

United Kingdom

Bose House
Quayside Chatham Maritime
KENT ME4 4QZ
TEL 44 (0)3330-142545

See website for other countries

Importer Information

European Union

Bose Products B.V., Gorslaan 60, 1441 RG Purmerend, The Netherlands

China

Bose Electronics (Shanghai) Company Limited, Part C, Plan 9, No. 353 North Riyang Road, China (Shanghai) Pilot Free Trade Zone

Taiwan

Bose Taiwan Branch, 9F-A1, No. 10, Section 3, Minsheng East Road, Taipei City 104, Taiwan
Tel: 886 2 2514 7977

Mexico

Bose de México, S. de R.L. de C.V., Paseo de las Palmas 405-204, Lomas de Chapultepec, 11000 México, D.F.
Tel: 001 800 900 2673



788759-0010

©2017 Bose Corporation, All rights reserved
Framingham, MA 01701-9168 USA
pro.Bose.com
All trademarks are property of their respective owners
AM788759 Rev. 00
November 2017

