

# MA9500

Integrated Amplifier

Owner's Manual



## Important Safety Information is supplied in a separate document “Important Additional Operation Information Guide”

### FCC Information (For US Customers)

#### 1. IMPORTANT NOTICE:

##### DO NOT MODIFY THIS PRODUCT

This product, when installed as indicated in the instructions contained in this manual, meets FCC requirements. Modification not expressly approved by McIntosh may void your authority, granted by the FCC, to use the product.

#### 2. CAUTION:

- To comply with FCC RF exposure compliance requirement, separation distance of at least 20cm must be maintained between this product and all persons.
- This product and its antenna must not be co-located or operating in conjunction with any other antenna or transmitter.

#### 3. COMPLIANCE INFORMATION:

- Product Name: Integrated Turntable
- Model Number: MTH100
- **This product contains FCC ID: SSS-BC11X:**  
McIntosh Laboratory, Inc.  
2 Chambers Street  
Binghamton, NY 13903  
Tel. (607) 723-3512

### IC Information (For Canadian Customers)

#### 1. PRODUCT:

##### **This product contains IC : 11012A-BC11X**

This product complies with RSS-210 of Industry Canada. Operation is subject to the following two conditions: (1) this product may not cause harmful interference, and (2) this product must accept any interference received, including interference that may cause undesired operation. This Class B digital apparatus complies with Canadian ICES-003.

#### 2. CAUTION:

To reduce potential radio interference to other users, the antenna type and its gain should be so chosen that the equivalent isotropically radiated power (e.i.r.p.) is not more than that permitted for successful communication.

### Informations sur IC (pour les clients Canadiens)

#### 1. APPAREIL:

##### **Cet appareil contient IC : 11012A-BC11X**

Cet appareil est conforme à la norme CNR-210 du Canada. L'utilisation de ce dispositif est autorisée seulement aux deux conditions suivantes : (1) il ne doit pas produire de brouillage, et (2) l'utilisateur du dispositif doit être prêt à accepter tout brouillage radioélectrique reçu, même si ce brouillage est susceptible de compromettre le fonctionnement du dispositif. Cet appareil numérique de la classe B est conforme à la norme

NMB-003 du Canada.

#### 2. ATTENTION:

Afin de réduire le risque d'interférence aux autres utilisateurs, il faut choisir le type d'antenne et son gain de façon à ce que la puissance isotrope rayonnée équivalente (p.i.r.e.) ne soit pas supérieure au niveau requis pour l'obtention d'une communication satisfaisante.

### Canadian Customers: CAN ICES-003 (B)/NMB-003 (B)

#### **RF Exposure Information**

This equipment complies with FCC/IC radiation exposure limits set forth for an uncontrolled environment and meets the FCC radio frequency (RF) Exposure Guidelines in Supplement C to OET65 and RSS-102 of the IC radio frequency (RF) Exposure rules. This equipment has very low levels of RF energy that are deemed to comply without testing of specific absorption ratio (SAR).

Cet équipement est conforme aux normes d'exposition aux radiations FCC/IC définies pour un environnement non contrôlé et satisfait les directives d'exposition à la radiofréquence (RF) dans le supplément C des OET65 et RSS-102 des règles d'exposition à la fréquence radio (RF) IC. Cet équipement a de très faibles niveaux d'énergie RF qui sont jugés conformes sans test de taux d'absorption spécifique (SAR).

### R&TTE(EN) Information

#### 1. DECLARATION OF CONFORMITY

Our products follow the provisions of EC/EU directives:

LV: 2006/95/EU

EMC: 2014/30/EU

RoHS: 2011/65/EU

ErP: EC regulation 1275/2008 and its frame work directive 2009/125/EC

#### 2. IMPORTANT NOTICE:

##### DO NOT MODIFY THIS PRODUCT

This product, when installed as indicated in the instructions contained in this manual, meets R&TTE directive requirements. Modification of the product could result in hazardous Radio and EMC radiation.

#### 3. CAUTION:

Separation distance of at least 20cm must be maintained between this product and all persons.

This product and its antenna must not be co-located or operating in conjunction with any other antenna or transmitter.

---

## Before You Begin, Read This!

---

We understand that you're eager to get started using your McIntosh, but to make sure you have the best possible experience up front, we highly recommend taking some time to thoroughly read through this manual and any included documentation. This will help to answer any questions you may have and make sure you stay safe and don't run into any issues that will prevent you from getting started quickly.

We have designed this manual to make sure your excitement doesn't wane by the time you fire up your unit. Experienced McIntosh users will find this manual as a valuable reference, while newer users will find it comprehensive enough to get started smoothly and effectively. As you read through the manual, you will find that everything is laid out intuitively, and everything is written succinctly and efficiently. We want you to spend less time reading, and more time listening.

If you are an experienced user and are confident in your ability to quickly get started on your own, you will find connection diagrams on Page 6 to help guide you along.

You are absolutely free to reach out to us to ask any questions or provide feedback about any aspect of your McIntosh experience. You can reach us via the contact information on the next page.

## Thank you from all of us at McIntosh

You have invested in a precision instrument that will provide you with many years of enjoyment. For the best experience and your safety, please be sure to heed and comply with the instructions and warnings found throughout the included documentation.

If you need further technical assistance, please contact your dealer who may be more familiar with your particular setup including other brands. You can also contact McIntosh with additional questions or in the unlikely event of needing service.

### McIntosh Laboratory, Inc.

2 Chambers Street  
Binghamton, New York 13903

Technical Assistance: ..(607) 723-3512

Fax: .....(607) 724-0549

Customer Service: .....(607) 723-3515

Fax: .....(607) 723-1917

Email: .....support@mcintoshlabs.com

Website: ..... mcintoshlabs.com

## Make a Note

For future reference, you can jot down your serial number and purchase information here. We can identify your purchase from this information if the occasion should arise.

Serial Number:	
Purchase Date:	
Dealer Name	





## Contents

<b>Trademark and License Information.....</b>	<b>4</b>
<b>Dimensions.....</b>	<b>4</b>
<b>Installation.....</b>	<b>5</b>
<b>Connecting Devices (Diagrams) .....</b>	<b>6</b>
Input and Control: .....	6
Output and Loudspeakers: .....	7
<b>Navigating the Rear Panel.....</b>	<b>8</b>
<b>Connector and Cable Information .....</b>	<b>9</b>
<b>Connecting Loudspeakers.....</b>	<b>10</b>
Preparing the Output Terminal Posts: .....	10
Preparing Your Speaker Wire: .....	10
Connecting Speakers (Bare Wire): .....	10
Connecting Speakers (Banana Plug): .....	10
Connecting Speakers (Spade Lug): .....	10
<b>Navigating the Front Panel .....</b>	<b>11</b>
<b>Navigating the Remote Control .....</b>	<b>12</b>
<b>Setting Up Your MA9500.....</b>	<b>13</b>
Using Knobs for Menu Navigation: .....	13
Entering Setup Menu: .....	13
Entering Trim Functions Menu:.....	13
Selecting/Adjusting Menu Settings:.....	13
Exiting/Navigating Back:.....	13
The Setup Menu:.....	13
Input Settings: .....	13
Output Settings: .....	13
Power Control Triggers Settings: .....	14
Data Ports Settings: .....	14
Passthru Settings: .....	14
HDMI CEC Settings:.....	14
HDMI Lip Sync Mode Settings: .....	14
Digital Gain Settings: .....	14
USB Automute Settings: .....	14
Comm Port Baud Rate Settings: .....	14
IR Codes Settings:.....	14
IR Sensor Settings: .....	15
Power Saving Settings: .....	15

Factory Reset: .....	15
<b>Using Your MA9500 .....</b>	<b>15</b>
Powering On/Turning Off: .....	15
Selecting an Input for Playback: .....	15
Adjusting the Volume: .....	15
Adjusting Trim Functions:.....	15
Adjusting Audio Balance: .....	15
Enabling/Disabling the Equalizer:.....	15
Adjusting Input Trim Levels:.....	15
Adjusting Phono Resistance (Turntables): .....	15
Toggling Stereo/Mono:.....	15
Toggling the Meter Backlights: .....	15
Adjusting Display Brightness: .....	15
Enabling/Disabling HXD:.....	15
Muting the Audio: .....	15
<b>Getting the Most Out of Your MA9500 .....</b>	<b>16</b>
Using the Autoformer: .....	16
Using the Eight-Band Equalizer: .....	16
Using Bi-Amplification on Loudspeakers: .....	16
Using the HXD with Headphones: .....	16
Listening Worry-Free (Auto Protection):.....	16
Using the Onboard Power Amplifier: .....	16
Using External Power Amplifiers:.....	16
Using MA9500 with External Amp: .....	16
Using Only External Amps:.....	16
Using Audio Passthru: .....	16
Viewing Coax/Optical Inputs Sample Rate: .....	16
Using USB Playback:.....	16
Installing the Software:.....	17
<b>Frequently Asked Questions .....</b>	<b>17</b>
<b>Amplifier Specifications.....</b>	<b>18</b>
<b>Digital Audio Specifications.....</b>	<b>18</b>
<b>General Specifications.....</b>	<b>19</b>
<b>Packing Instructions.....</b>	<b>19</b>
<b>MA9500 Packing Material List.....</b>	<b>19</b>

## Trademark and License Information

The McIntosh MA9500 incorporates copyright protected technology that is protected by U.S. patents and other intellectual property rights. The MA9500 uses the following Technologies:

Trademark	License Information
	ASIO is a trademark and software of Steinberg Media Technologies GmbH
	Manufactured under license from Dolby Laboratories. Dolby, Dolby Audio, and the double-D symbol are trademarks of Dolby Laboratories.
	For DTS patents, see <a href="http://patents.dts.com">http://patents.dts.com</a> . Manufactured under license from DTS, Inc. DTS, the Symbol, DTS and the Symbol together, and Digital Surround are registered trademarks and/or trademarks of DTS, Inc. in the United States and/or other countries. DTS, Inc. All Rights Reserved.
	The terms HDMI, HDMI High-Definition Multimedia Interface, and the HDMI Logo are trademarks or registered trademarks of HDMI Licensing Administrator, Inc.

## Dimensions

Front View:

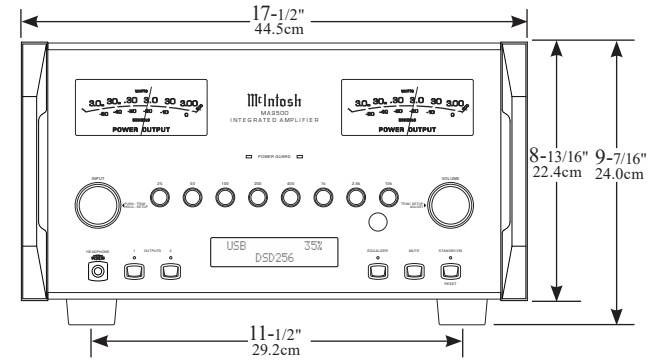

Side View:

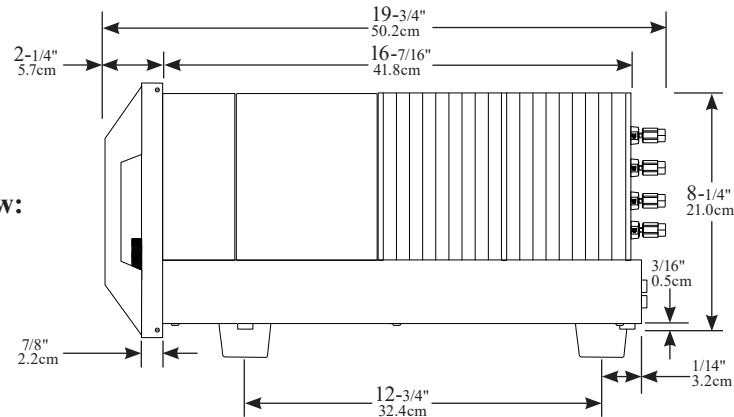

Rear View:

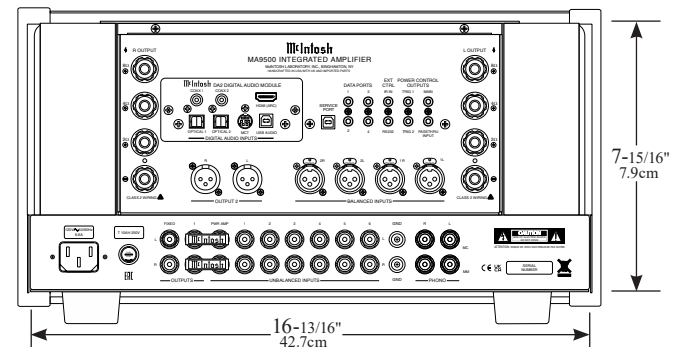

## Installation

**WARNING: The MA9500 is heavy (approx. 101 lbs). Please get help when moving the unit, and make sure your furniture or cabinetry is sturdy enough to hold it.**

The MA9500 can be placed upright on a table or shelf, standing on its four feet. It also can be custom installed in a piece of furniture or cabinet of your choice. The four feet may be removed from the bottom of the MA9500 when it is custom installed as outlined below. The four feet together with the mounting screws should be retained for possible future use if the MA9500 is removed from the custom installation and used free standing. The required panel cutout, ventilation cutout and unit dimensions are shown.

Always provide adequate ventilation for your MA9500. Cool operation ensures the longest possible operating life for any electronic instrument. Do not install the MA9500 directly above a heat generating component such as a high powered amplifier. If all the components are installed in a single cabinet, a quiet running ventilation fan can be a definite asset in maintaining all the system components at the coolest possible operating temperature.

A custom cabinet installation should provide the following minimum spacing dimensions for cool operation.

Allow at least 6 inches (15.24cm) above the top, 2 inches (5.08cm) below the bottom and 2 inches (5.1cm) on each side of the Integrated Amplifier, so that airflow is not obstructed. Allow 20 inches (50.8cm) depth behind the front panel. Allow 1-7/6 inch (3.66cm) in front of the mounting panel for knob clearance. Be sure to cut out a ventilation hole in the mounting shelf according to the dimensions in the drawing.

### Notes:

1. If you remove the feet from your unit, be sure not to lose them, as they will need to be reattached if you need to send the unit back for service.
2. Use an appropriately-sized Phillips drill bit, or you may cause damage to the screw heads, making the feet impossible to remove.

MA9500 Front Panel  
Custom Cabinet Cutout

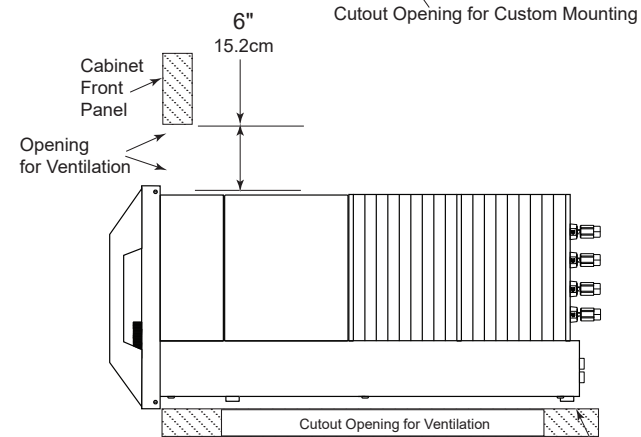
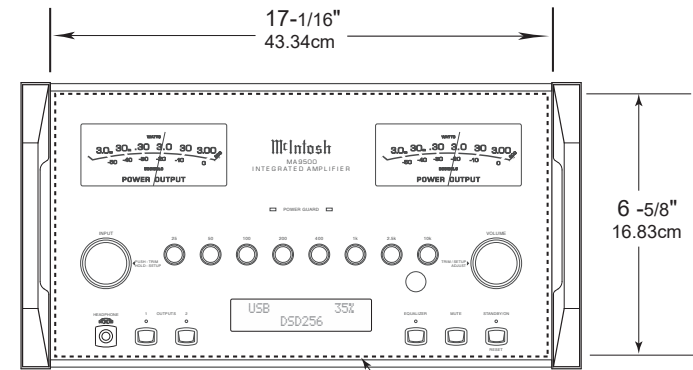

MA9500 Side View  
in Cabinet

MA9500 Bottom View  
in Custom Cabinet

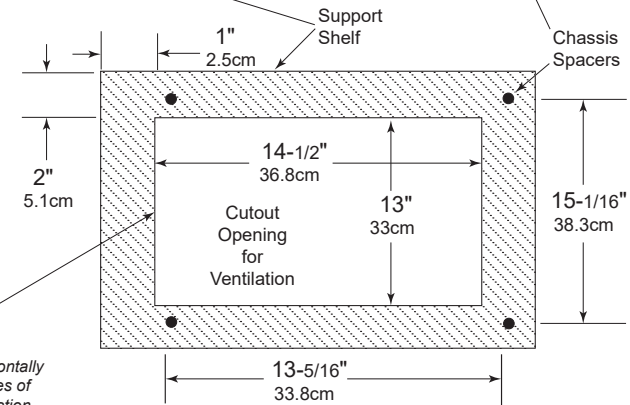

Note: Center the cutout horizontally on the unit. For purposes of clarity, the above illustration is not drawn to scale.

# Connecting Devices (Diagrams)

## Input and Control:

**Connection Legend:**

- Data Cable\* 
  - Sensor/Keypad Cable 
  - Power Control Cable\* 
  - Loudspeaker Cable 
  - Digital Signal Cable 
  - Ground Wire 
  - Audio Signal Cable 
- \* 2 conductor shielded with 1/8 inch stereo mini phone plug on each end.

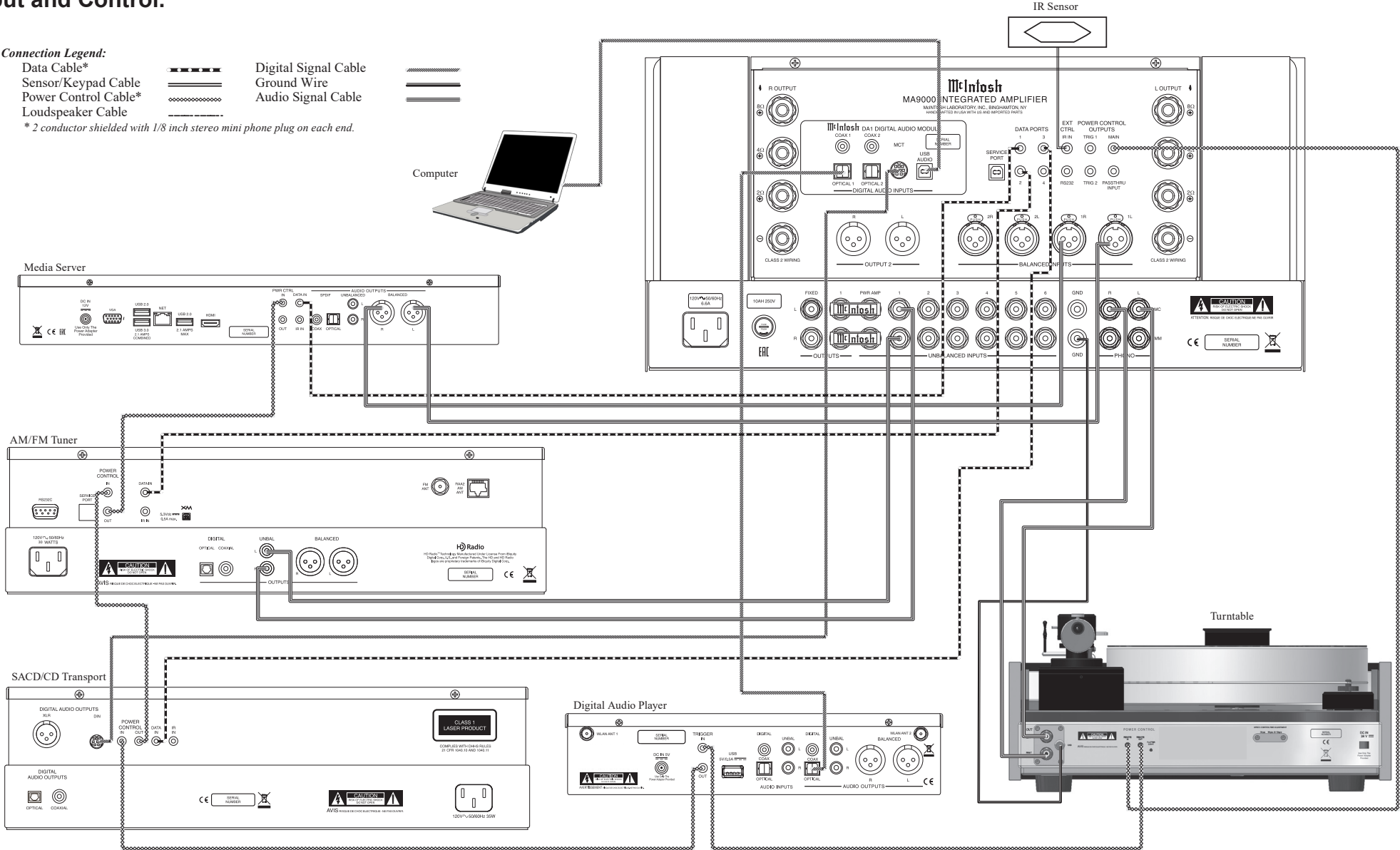

# Output and Loudspeakers:

**Connection Legend:**

- Data Cable\* Digital Signal Cable
- Sensor/Keypad Cable Ground Wire
- Power Control Cable\* Audio Signal Cable
- Loudspeaker Cable

\* 2 conductor shielded with 1/8 inch stereo mini phone plug on each end.

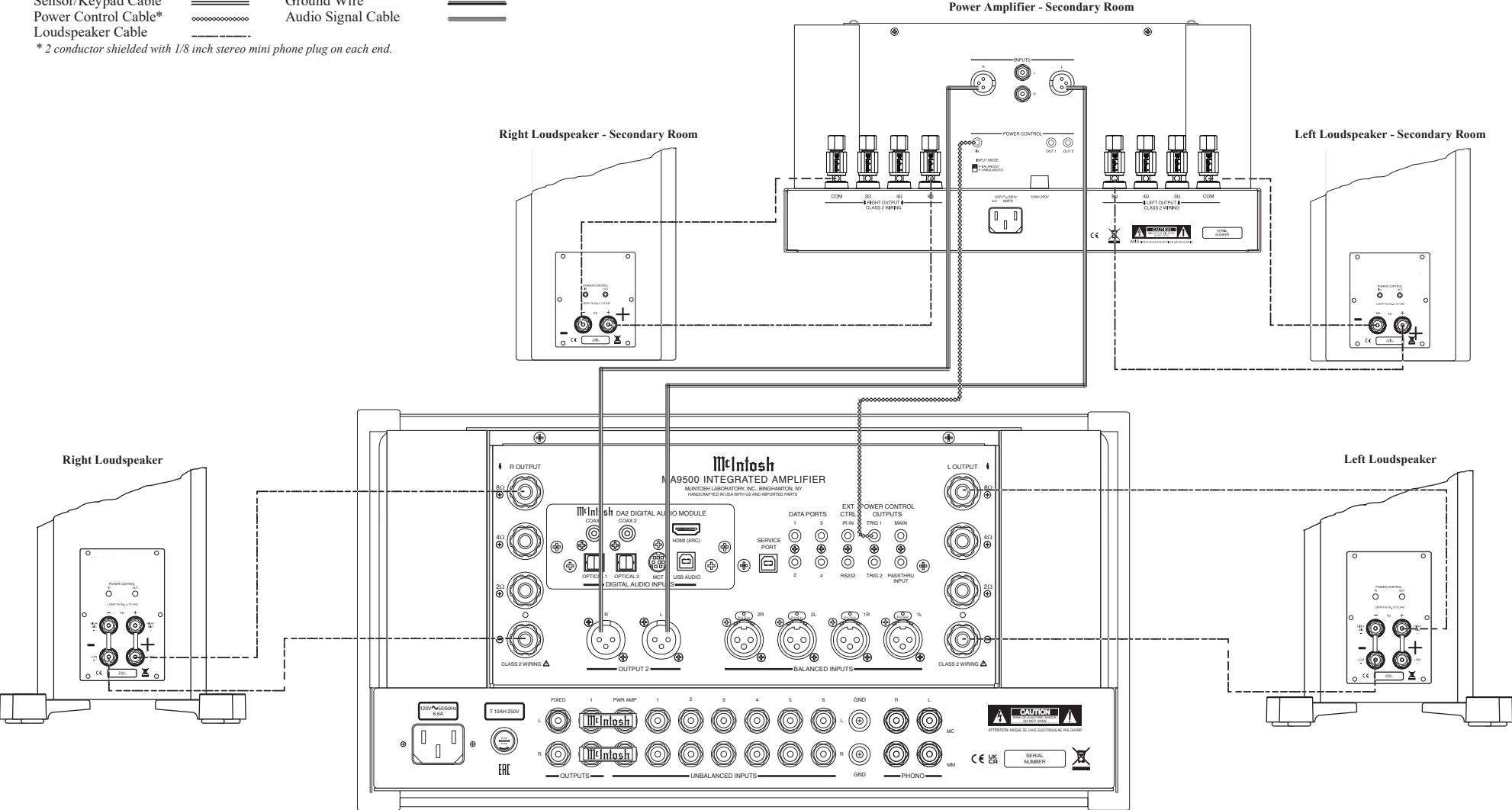

## Navigating the Rear Panel

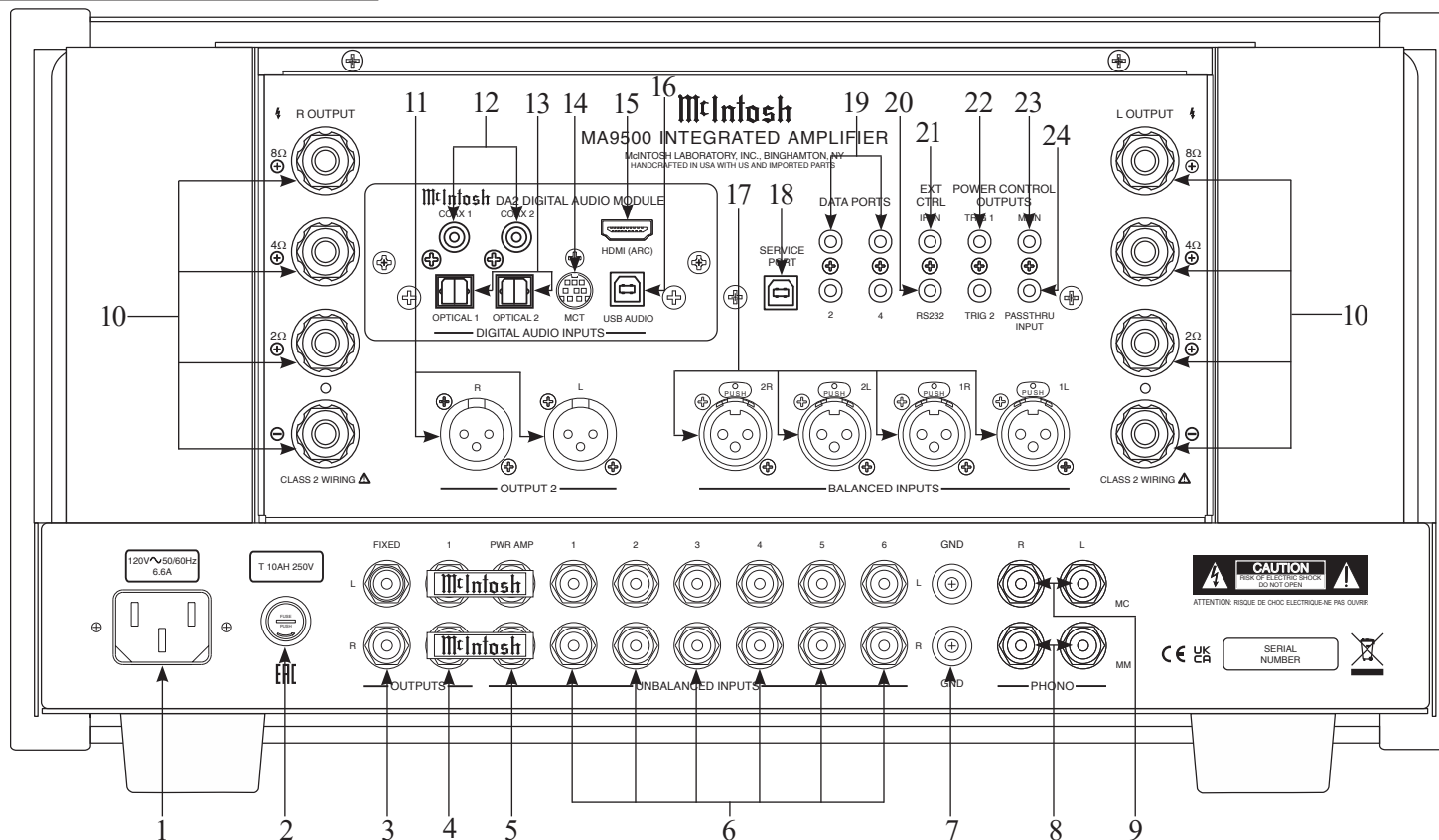

**1. Main Power:** Attach the included power cable here.

**2. Main Fuse Holder:** This is where the main fuse to power the unit is located.

**3. Fixed Outputs:** An RCA connector cable will produce a fixed, non-adjustable Volume level signal from here.

**4. Output 1:** Use this port with an RCA cable to send the signal to a subwoofer or power amplifier. Connect included Jumper Plugs (see next page) to this port and PWR AMP to use onboard amp (see Page 16).

**5. PWR AMP Input:** The included Jumper Plugs (see next page) connect Output 1 to the onboard power amplifier (see Page 16). Also used as a loop for room correction with Output 1.

**6. Unbalanced Inputs (1-6):** You can connect up to six high-level unbalanced signals using an RCA connection with these ports.

**7. GND Input:** This is where you would put a ground wire from a turntable to prevent noise.

**8. MM Phono Input:** A turntable with a moving magnet cartridge will plug in here with an RCA cable.

**9. MC Phono Input:** A turntable with a moving coil cartridge will plug in here with an RCA cable.

**10. Loudspeaker Output Terminal Posts:** Connect loudspeakers to these posts (see Page 10).

**11. Output 2:** Use an XLR connector cable for a balanced output signal from these ports.

**12. Coax Inputs (1 and 2):** You will connect coaxial cables for digital signals into these ports.

**13. Optical Inputs (1 and 2):** These ports accept optical connections for digital signals.



**14. MCT Input:** Used to transfer signals from McIntosh products with an MCT connector. Required for SACD audio.

**15. HDMI (ARC) Input:** Connect an HDMI cord here to share control and connectivity with a compatible ARC TV.

*Note: The HDMI ARC functionality of the MA9500 is only compatible with ARC TVs. Other devices will not work.*

**16. USB Audio Input:** A USB Type-B connector will go here to receive a digital signal from a computer.

**17. Balanced Inputs:** Plug in an XLR connector cable (see next page) to these ports for balanced signals.

**18. Service Port:** This USB Type-B port will be used for service purposes only.

**19. Data Ports (1-4):** Using 3.5mm data cables (see next section), you can plug other McIntosh devices into these ports and control them with your McIntosh Remote Control.

**20. RS232 Port:** Using a 3.5mm-to-DB9 cable (see next section), you can connect the device to a computer or another controller device through here.

**21. IR In Port:** Connect an external IR sensor here with a 3.5mm connector (see next section).

**22. Trigger Ports (1 and 2):** Connecting external components to these ports via a 3.5mm connection (see next section) will allow you to send a signal to turn those devices On or Off from a signal sent by the MA9500.

**23. Main Output Control Port:** McIntosh devices can turn each other On and Off when connected via a 3.5mm connector (see next section) to these ports.

**24. Passthru Input:** Connecting other devices with a 3.5mm connector (see next section), in addition to

their main connection, will enable Passthru Mode when enabled in the Setup Menu (see Page 13), producing unaltered audio.

---

## Connector and Cable Information

---

### XLR Connectors

Below is the Pin configuration for the XLR Balanced Input Connectors on the MA9500. Refer to the diagram for connection:

PIN 1: Shield/Ground  
PIN 2: + Output  
PIN 3: - Output

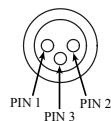

### Power Control and Trigger Connectors

The Power Control Trigger Output Jacks send and Passthru Input Jack receives Power On/Off Signals (+12 volt/0 volt) when connected to other McIntosh Components. An additional connection is for controlling the illumination of the Power Output Meters on McIntosh Power Amplifiers. A 3.5mm stereo mini phone plug is used for connection to the Power Control, Trigger and Passthru Outputs.

#### Main, Trig 1&2 and Pass-Thru

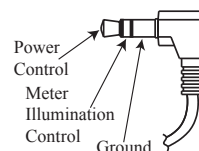

### Data Port Connectors

The Data Out Ports send Remote Control Signals to Source Components. A 3.5mm stereo mini phone plug is used for connection.

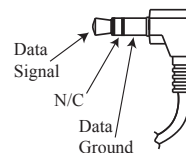

### IR IN Port Connectors

The IR IN Port also uses a 3.5mm stereo mini phone plug and allows the connection of other brand IR Receivers to the MA9500.

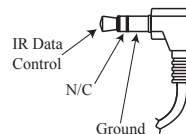

### RS232-C Data Port Cable

The RS232 Data Cable is a 3.5mm stereo mini phone plug to a sub miniature DB 9 connector:

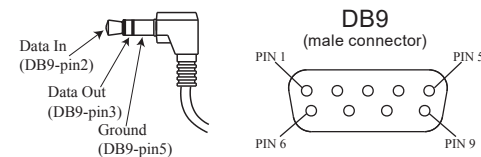

### Output Terminal Connector

When cables with spade lugs are used for Loudspeaker Connection, the spade lugs need an opening of at least 3/10 inch (7.6mm)

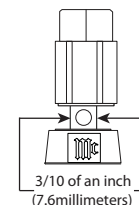

### McIntosh Plug-In Jumper Connector (x2 Included)

The MA9500 utilizes two phono style Plug-In Jumpers to connect the Preampifier Output to the Power Amplifier Input.

*Note: Additional or replacement Jumper Connectors can be obtained from the McIntosh Parts Department under Part No. 117781.*

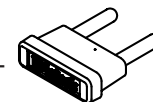

## Connecting Loudspeakers

**WARNING:** To avoid injury due to electrical shock or damage to your unit, do not attempt to attach loudspeakers while the MA9500 is plugged into a power outlet.

### Preparing the Output Terminal Posts:

Notes:

1. When attaching loudspeakers, make sure the wires you used for positive (+) polarity is connected between the matching positive connectors on both the speakers and the unit. Do the same for the wires you used for negative (-) polarity. Do not make a connection between the separate channels (left and right).
2. Refer to your speakers' documentation to determine the correct Output Terminal Post to connect them to based on their ohm impedance. If your speaker ohm impedance falls between the MA9500s labeled Output Terminal Posts, used the nearest lower connection. Example: If your speakers have a 6-ohm impedance, connect them to the 4-ohm Output Terminal Post.
3. If you're using banana plugs, loosening the Output Terminal Posts is not necessary. Make sure the posts are tight before you attach the banana plugs.

To prepare the Output Terminal Posts for wires, unscrew them with your fingers counterclockwise until the opening on the post is exposed. When wires are set inside, tighten by turning the posts clockwise until they stop, **making sure not to overtighten\***. Finally, to secure the wires in place, use the included McIntosh Wrench and turn the posts one quarter turn (90°) clockwise.

**\*WARNING: Overtightening can cause damage.**

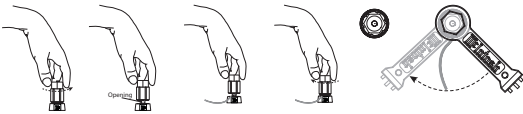

### Preparing Your Speaker Wire:

Your speaker cord will have two sections, each with a set of wires in casing – one for each polarity (positive and negative). Using your choice of tool (such as pliers or clippers), take one cord section from one end and gently cut away and remove about ½ inch of the outer casing, making sure not to cut the internal wires. Once the casing is removed and the wires are exposed, use your fingers to twist the wires together until they are as narrow as possible, resembling a screw. Repeat this process for the remaining sections on both ends of the speaker cord.

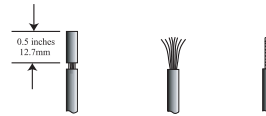

### Connecting Speakers (Bare Wire):

After loosening the Output Terminal Posts, you will see an opening. Place your narrowed wires you previously exposed through the opening and tighten the posts using the method described in “Preparing the Output Terminal Posts”.

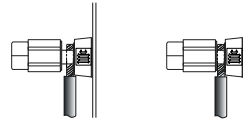

### Connecting Speakers (Banana Plug):

Make sure the Output Terminal Posts are tightened via the method described in “Preparing the Output Terminal Posts” (if necessary) and connect the banana plugs into the holes of the appropriate posts.

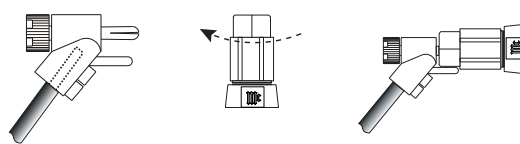

### Connecting Speakers (Spade Lug):

While the Output Terminal Posts are unscrewed, slip the openings of the forks of the spade lugs around the inner part of the posts, and tighten the posts using the method described in “Preparing and Tightening the Output Terminal Posts”.

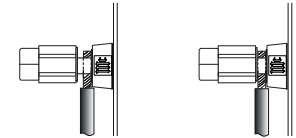

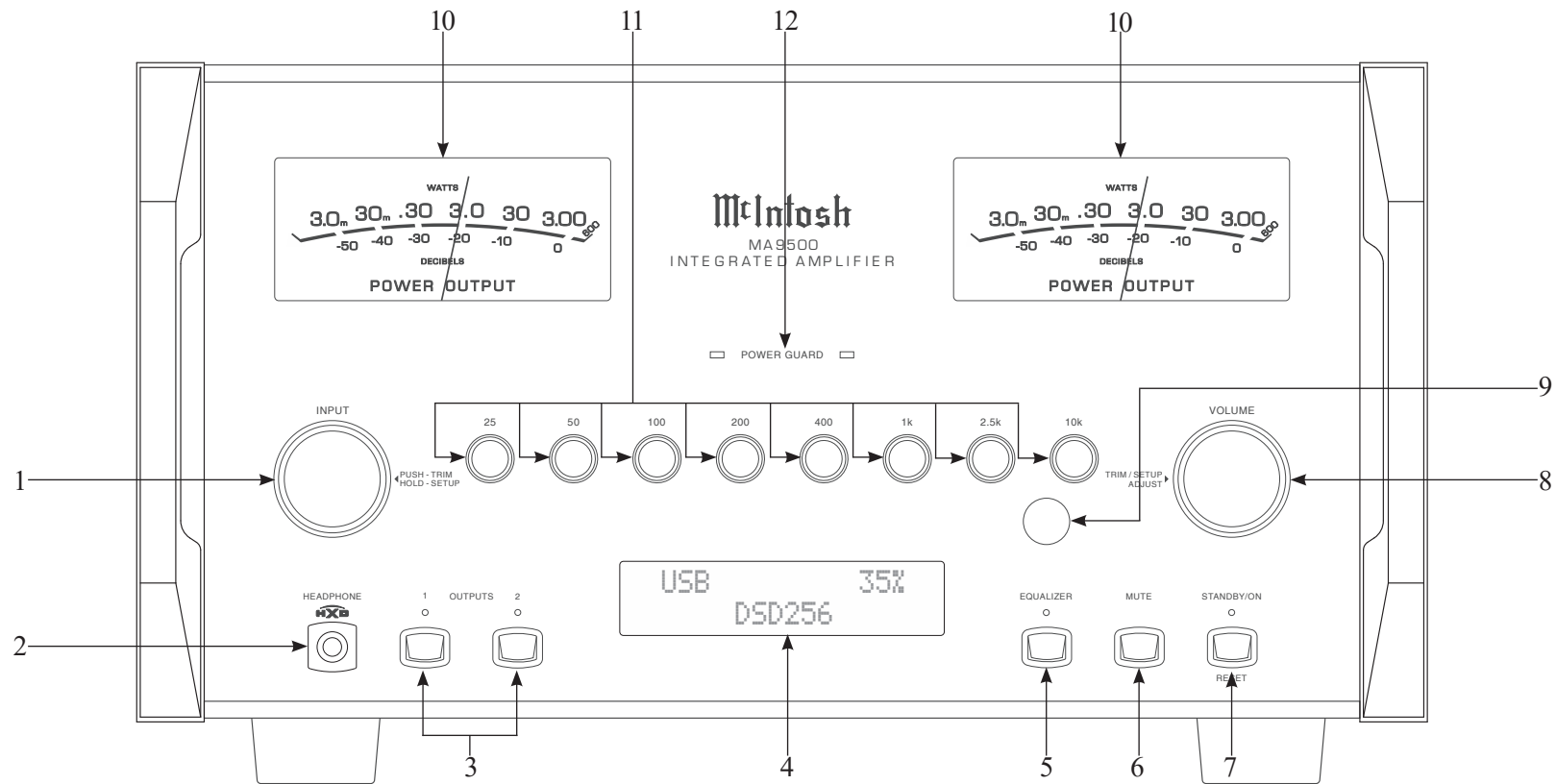

## Navigating the Front Panel

**1. Input Control Knob:** Rotate this to select different Input sources for playback, as well as navigate through different options in the menus. Access menus by holding or pressing the Knob in (see Page 13).

**2. Headphone Jack:** Plug in your .25" headphones here to gain access to the headphone amplifier.

**3. Outputs Toggle Buttons (1 and 2):** You can toggle playback through the outputs using these buttons.

**4. Information Display:** This will show information based on your current selection. Shows inputs and Menu options for navigation.

**5. Equalizer Toggle Button:** Toggle the Equalizer (see Page 16) On or Off for the currently selected Input with this button.

**6. Mute Button:** This will mute all audio playback from the MA9500.

**7. Standby/On Button:** You can turn the device On or Off - put it in Standby Mode - using this button.

**8. Volume Knob:** Adjust the Volume with this Knob. You will also use this to adjust Settings in the menus (see Page 13).

**9. IR Sensor:** This is how the MA9500 receives commands from your Remote Control.

**10. Power Output Meters:** These gauge the power Output from the amplifier channels.

**11. Frequency Adjustment Knobs:** These will adjust the frequencies marked above each Knob for the sound coming through the any Input that has the Equalizer (see Page 16) is activated.

**12. Power Guard Lights:** These LED lights will illuminate when McIntosh's patented Power Guard (see Page 16) automatically kicks on to prevent playback distortion and protect your system from damage.

## Navigating the Remote Control

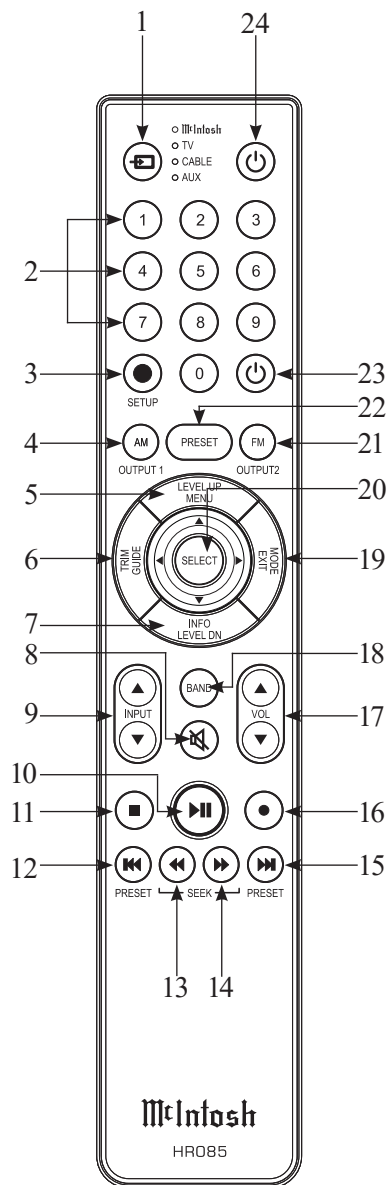

**1. Switch Device:** Select different devices for remote operation. Selected device is indicated by the LED light when buttons are pressed.

**2. Numbers:** You can select tuner presets and manually enter disc tracks and radio stations – among other numerical functions – using these buttons.

**3. Setup:** The Setup Button gives you access to the additional functions for the buttons represented in blue text. It's like using the "Shift" key on a keyboard to access special characters above the number keys. *(Note: Cannot be used to enter Setup Mode.)*

**4. AM Tuner/Output 1:** Access AM Tuner or press Setup followed by this button to toggle Output 1.

**5. Level Up/Menu:** Adjusts trim functions settings. Accesses menu on compatible devices.

**6. Trim/Guide:** Enters Trim Functions Menu. Opens guide on compatible devices.

**7. Info/Level Down:** Adjusts trim functions settings. Accesses info on compatible devices.

**8. Mute:** Mutes audio playback.

**9. Input:** Changes and selects different inputs.

**10. Play/Pause:** Pressing this button will halt playback of active media, and it will resume from where it left off if you press the button again.

**11. Stop:** Cancels media playback and resets progress through it.

**12. Previous/Previous Preset:** You can go back to your previous media selection by pressing this button. Also allows you to navigate to a previous tuner preset.

**13. Fast Reverse/Seek Down:** Navigate backwards through the current active media using this button. This is also used to adjust the tuner downwards.

**14. Fast Forward/Seek Up:** Navigate forward through the current active media using this button. This is also used to adjust the tuner upwards.

**15. Next/Next Preset:** You can go forward to your next media selection by pressing this button. Also allows you to navigate to a later tuner preset.

**16. Record:** On devices with a record function, this will begin recording the actively playing media.

**17. Volume:** Adjust the volume with these buttons.

**18. Band:** You will have the option to change the band on your connected tuner or select certain options on a variety of McIntosh models.

**19. Mode/Exit:** This will exit the Trim Functions Menu. It will also display information or certain options.

**20. Select:** Where applicable, you can press this button to select any highlighted option.

**21. FM Tuner/Output 2:** Access FM Tuner or press Setup followed by this button to toggle Output 2.

**22. Preset:** Press this button followed by a number (0-9) to immediately select that stored preset.

**23. Power Off:** Whichever device you have selected on the remote control will turn off when you press this button.

**24. Power On:** Whichever device you have selected on the remote control will turn on when you press this button.

*Note: The included McIntosh HR085 Remote Control has buttons used to control multiple devices. While operating the MA9500 with the remote, nothing will happen when pressing buttons that activate features not present on the MA9500. Refer to HR085 Owner's Manual on [www.mcintoshlabs.com](http://www.mcintoshlabs.com).*

---

## Setting Up Your MA9500

---

### Using Knobs for Menu Navigation:

In addition to their normal use, you will use the Input Control Knob and the Volume Knob to enter the Menu, navigate through the selections, and adjust the different Settings options.

#### Entering Setup Menu:

To enter the Setup Menu, hold the Input Control Knob. Once the Display shows the unit model, the firmware version, and the serial number, release the Knob and you are in the Setup Menu. See next section for the Setup Menu overview.

*Note: "Enter Code" will appear if the Input Control Knob is held too long. This is for support purposes only. Press the Knob again to exit.*

#### Entering Trim Functions Menu:

A brief deliberate press (not hold) and release of the Input Control Knob will take you to the Trim Functions Menu. See Page 15 for the Trim Functions overview.

#### Selecting/Adjusting Menu Settings:

You can navigate through and select the different options in the menus by rotating the Input Control Knob. To adjust a selected Setting, use the Volume Knob. If a category in a Menu has a Submenu available, the Display will show "Hold Input", allowing you to hold down the Input Control Knob to see additional options.

#### Exiting/Navigating Back:

A brief deliberate press (not hold) and release of the Input Control Knob will exit the current Menu. Make additional presses until the Display shows the main operating screen to continue normal use of the unit.

### The Setup Menu:

See the previous section for instructions on entering, navigating, and adjusting Settings in the Setup Menu. The following is a list of the available Settings options in the Setup Menu as they will appear on your Display. A down arrow ↓ represents being taken to a Submenu after holding the Input Control Knob while the Display says "Hold Input". The selectable options will be listed in brackets [ ] and separated by commas, with a brief description underneath of what each option does when selected.

#### Input Settings:

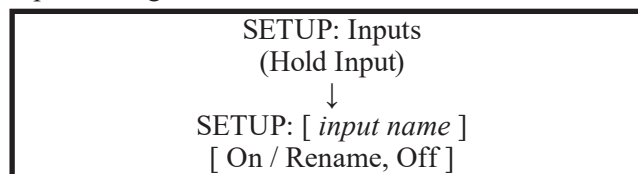

**On / Rename:** The selected Input will be functioning as normal. Hold in the Input Control Knob to enter the Menu to rename the Input\*.

**Off:** The selected Input will be deactivated and will no longer be selectable from the Main Display during normal use. Change this Setting back to "On / Rename" to make it selectable again.

**\*Renaming Inputs:** While in this inputs Submenu, use the Input Control Knob to navigate to the Input with the name you'd like to change (and turn it On using the Volume Knob if it isn't already) so that the Display says "SETUP: [ input name ] On / Rename" and hold the Input Control Knob to begin renaming. The character you are currently adjusting will be blinking. Rotate the Input Control Knob to select which character you want to change and use the Volume Knob to change the character.

### Output Settings:

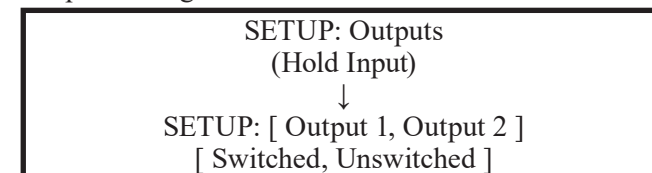

**Switched:** The front panel/Remote Control Output buttons will function as normal, allowing you to toggle On and Off the outputs.

**Unswitched:** The front panel/Remote Control Output buttons will be deactivated and the outputs will be always On.



**Mute All Outputs:** When headphones are plugged in, mute audio from all other outputs and play audio from the headphones exclusively.

**Mute No Outputs:** When headphones are plugged in, continue to play audio through other outputs as normal in addition to the audio from the headphones.

### Power Control Triggers Settings:

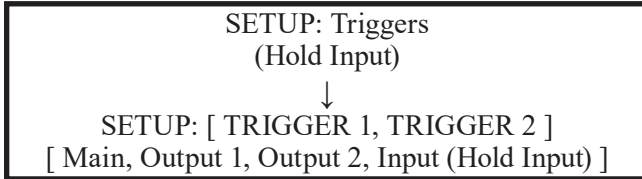

**Main:** An On/Off signal is sent to devices attached to the TRIG 1 and TRIG 2 ports when the MA9500 is turned On or Off.

**Output 1:** Turns On/Off any devices attached to either TRIG 1 or TRIG 2 when Output 1 is activated, either via the front panel buttons or the Remote Control.

**Output 2:** Turns On/Off any devices attached to either TRIG 1 or TRIG 2 when Output 2 is activated, either via the front panel buttons or the Remote Control.

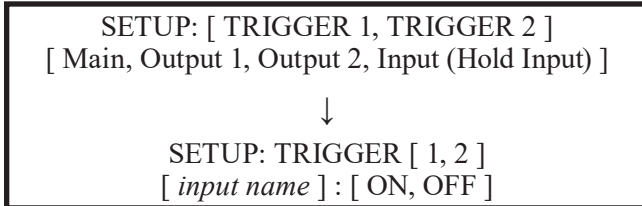

[ *input name* ] : **ON:** Turns On/Off any devices attached to TRIG 1 or TRIG 2 when the Input is selected on the Main Display during normal use.

[ *input name* ] : **OFF:** Prevents any devices attached to TRIG 1 or TRIG 2 from turning On/Off when the Input is selected on the Main Display during normal use.

### Data Ports Settings:

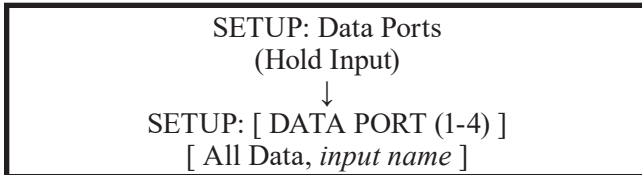

**All Data:** Devices connected to all four data ports will receive the same data from the Remote Control.

[ *input name* ]: Dedicate one of the data ports to a specific Input, forcing that data port to only send data received from that Input when it receives commands from the Remote Control.

### Passthru Settings:



[ *input name* ]: Enables Passthru for the signal received by the MA9500 from the selected Input, which will bypass the onboard preamplifier and send it straight to the onboard power amplifier without altering it in any way.

**Off:** Disables Passthru, and the MA9500 will process each Input signal as normal.

### HDMI CEC Settings:



**ON:** Allows compatible devices to use CEC (Consumer Electronics Control) to control certain functions of the MA9500.

**OFF:** Prevents MA9500 from being controlled w/ CEC.



**ON:** Allows compatible devices to use CEC (Consumer Electronics Control) to power On/Off the MA9500 or be powered On/Off by the MA9500.

**OFF:** Prevents devices from using CEC to power On/Off the MA9500 or be powered On/Off by the MA9500.

### HDMI Lip Sync Mode Settings:



**Auto:** The MA9500 will automatically synchronize video and audio signals received through HDMI.

**Manual:** Disabled auto video/audio synchronization through HDMI, allowing you to manually calibrate audio/video sync from connected devices.

### Digital Gain Settings:

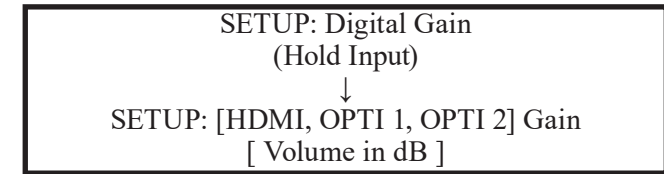

To get more even playback Volume from your connected digital devices, adjust their individual volumes with this Setting. The defaults are +15dB for HDMI and +0dB for Optical.

### USB Automute Settings:



**On:** Mutes USB playback for the first half of a second to prevent the audible "noise burst" that sometimes occurs when switching digital files or signals.

**Off:** USB playback will not be muted when switching digital files or signals.

### Comm Port Baud Rate Settings:



The speed at which the MA9500 communicates with devices plugged into the Comm Port (the Baud Rate) can be adjusted with this Setting. It is recommended to leave this at the highest Setting of 115200.

### IR Codes Settings:



By default, the included HR085 Remote Control sends "Normal" IR codes when buttons are pressed. Any McIntosh device set to receive "Normal" IR codes will receive the signal. To prevent controlling multiple devices with the Remote at once, change this Setting to "Alternate" to prevent signals from the Remote being read. You can also set the Remote itself to send "Alternate" codes. Refer to the HR085 manual on the McIntosh website for instructions on how to do so.

### IR Sensor Settings:

SETUP: Front IR  
[ Enabled, Disabled ]

You can enable or disable the functionality of the IR sensor to change whether or not the MA9500 will accept commands from the Remote Control. You may want to do this if you have an external IR sensor that operates the MA9500 with other devices.

### Power Saving Settings:

SETUP: Auto-Off  
[ Enabled, Disabled ]

**Enabled:** The MA9500 automatically enters Standby Mode after approximately 30 minutes of inactivity.

**Disabled:** The MA9500 will not power Off automatically and will remain On until you turn it Off.

### Factory Reset:

FACTORY RESET  
(Hold Input)

While on this option, hold the Input Control Knob until the Display says "In Progress!" and immediately release. Once the Display says "Completed!", your unit's Settings will be set back to their factory defaults.

---

## Using Your MA9500

---

*Note: In the unlikely event that your commands are no longer being registered by the unit, you can try resetting the microprocessors. To do so, hold the Standby/On button down until the LED power indicator light switches Off. Release the button, and when the light illuminates again, you can press the button again to power the unit On and resume normal operation. This will also revert the Settings to factory defaults. Be sure to let off the button as soon as the LED lights back up.*

### **Powering On/Turning Off:**

While the unit is in Standby Mode (no lights except the LED indicator light are On), press the Standby/On front panel button to power On the unit. While the unit is On, press the button to enter Standby Mode (turn it Off). Using the Remote Control, press the Power On and Power Off buttons where appropriate.

### **Selecting an Input for Playback:**

You can change the current playback source by rotating the Input Control Knob or by using the Input Buttons on the Remote Control.

### **Adjusting the Volume:**

Rotate the Volume Knob or use the Volume Buttons on the Remote Control to adjust the Volume. The current Volume level is represented by a percentage on the Display. *Note: The Volume control does not affect audio through the Fixed Outputs.*

### **Adjusting Trim Functions:**

See Page 13 for instructions on entering, navigating, and adjusting Settings in the Trim Function Menu. The Remote Control will also adjust these Settings.

*Note: The Balance, Input Trim, and Equalizer Settings in this Menu will only be adjusted and affect the currently selected Input and their configurations will be independently saved.*

The following is a list of descriptions of the various options in the Trim Functions Menu.

#### Adjusting Audio Balance:

You may want one loudspeaker to be louder than the other. While on the Balance Setting, use the Volume Knob to adjust the meter to whichever channel you wish to be louder. The more filled the meter is under a channel, the louder that channel will get, while the opposite channel will get quieter.

#### Enabling/Disabling the Equalizer:

Turning On the Equalizer will allow you to adjust the sound frequency for the selected Input using the

Frequency Adjustment Knobs. Sound will adjust for each Input that has it activated. *Note: The Equalizer does not affect audio through the Fixed Outputs..*

#### Adjusting Input Trim Levels:

Devices connected to the various inputs may be sending audio at varying volumes to the MA9500. This could result in uneven playback Volume when changing sources. To correct this, you can raise or lower the Volume of an Input as it enters the MA9500 by adjusting its Trim level with this Setting.

#### Adjusting Phono Resistance (Turntables):

With the MC Phono source Input selected, the option to change the phono resistance becomes available in the Trim Functions Menu. Make sure to match this number to your turntable's recommended phono resistance level.

#### Toggling Stereo/Mono:

Stereo allows the left and right channels to have separate independent audio signals. Mono sends the same signal through both channels. You can toggle between the two with this Setting.

#### Toggling the Meter Backlights:

You can turn On/Off the illumination of the power meters here.

#### Adjusting Display Brightness:

Use the Volume Knob to adjust the Brightness level of the Display.

#### Enabling/Disabling HXD:

This option will become available if headphones are plugged in. Enable this option to experience McIntosh's patented Headphone Crossfeed Director (HXD) or disable it to have unaltered audio playback through the headphones.

### **Muting the Audio:**

Use the mute button on the front panel or the Remote Control to mute the audio coming from the MA9500.

---

## Getting the Most Out of Your MA9500

---

### Using the Autoformer:

Your MA9500 comes equipped with independent connectors specifically allocated for loudspeakers of 2-, 4-, and 8-ohm impedance. Separating these connections allows McIntosh to use its patented Autoformer to provide the full 200 watts of power regardless of your speakers' specifications.

### Using the Eight-Band Equalizer:

As with all McIntosh products, your MA9500 produces the clearest, most accurate form possible of any audio that pumps through it. If the audio sent from the source is suboptimal, however, then the "clearest, most accurate form" might not be ideal for every situation. If you find yourself wanting to adjust the audio frequencies, enable the Equalizer (with the button on the front panel or in the Trim Functions Menu) to activate the functionality of the eight Frequency Adjustment Knobs. Turning the Knobs will adjust from the low frequencies (25Hz) up to the high frequencies (10,000Hz). Experiment with different rotations of the knobs to produce your desired sound. The Equalizer will affect the sound for any Input that has it on, and its On/Off status will be saved per Input.

### Using Bi-Amplification on Loudspeakers:

**WARNING:** *If the loudspeakers you are attempting to connect for bi-amplification have Jumper Plugs connecting the mid/high and low frequencies, they must be removed before making the connections to the amplifier(s). Failure to do so may result in damage to your equipment.*

The MA9500's onboard power amplifier may be used in conjunction with a separate external power amplifier to connect a loudspeaker for bi-amplification, allowing more flexible power control to the separate mid/high and low frequencies of the loudspeaker. You will do this by first removing the McIntosh Jumper Plugs from the Output 1 ports and the PWR AMP ports on the MA9500. In their place, bridge each of

the left and right channels of the Output 1 and PWR AMP ports with a shielded RCA Y splitter. Connect the open ends of each of the Y splitters to your separate external power amplifier.

### Using the HXD with Headphones:

Enable Headphone Crossfeed Director (HXD) to improve the sound localization for your headphones. HXD restores the directionality component of the spatial sound stage, giving you the quality and immersion of a loudspeaker paired with the privacy of headphones.

### Listening Worry-Free (Auto Protection):

The internal McIntosh Power Guard monitors and adjusts sound waves at the speed of light, preventing harsh sounding distortion and clipping that could damage your speakers. The Power Guard LED lights on the front panel will be lit when it automatically activates. The MA9500 also includes an internal Sentry Monitor, which gauges the amount of incoming electricity and will automatically protect your unit in the event of improper current flow, allowing you to listen while knowing your unit is safe.

### Using the Onboard Power Amplifier:

To use the internal preamplifier and power amplifier simultaneously, connect the Output 1 ports and the PWR AMP ports using the included Jumper Plugs. This audio will be produced through Output 1.

### Using External Power Amplifiers:

While your MA9500 comes fully equipped with a preamplifier and a power amplifier with the capability of playing the crystal-clear audio you'd expect from McIntosh amps through your loudspeakers, you have the option to attach separate power amplifiers if you so choose. You can do this while using the onboard power amplifier, or you can disable the onboard power amplifier and only use separate ones.

### Using MA9500 with External Amp:

Connect your loudspeakers to the MA9500 and use the Output 2 ports to send a signal to an external amplifier, leaving the McIntosh Jumper Plugs that are bridging the Output 1 ports and the PWR AMP ports right where they are.

### Using Only External Amps:

To disable the functionality of the onboard power amplifier, disconnect any loudspeakers from the MA9500 and remove the McIntosh Jumper Plugs bridging the Output 1 ports and the PWR AMP ports. This will turn your MA9500 into a dedicated preamplifier, allowing you to send signals from Output 1 and Output 2 to external power amplifiers.

### Using Audio Passthru:

When using the MA9500 as part of a home theater system, you will likely want to enable audio Passthru to ensure proper flexibility with your audio signals. To do this, connect a cable from one of your A/V processor's trigger ports to the MA9500's Passthru Input port. Then, connect left and right audio signals from the A/V processor to a left and right Input port, respectively, on the MA9500. Finally, enable that Input for Passthru in the Setup Menu (see Page 14).

### Viewing Coax/Optical Inputs Sample Rate:

When coaxial or optical inputs are selected and producing a signal, the Display will show the sample rate of the signal under the input name. If no signal is being received through the inputs, the Display will show a dotted line under the input name.

### Using USB Playback:

You can play audio from your computer through the MA9500 while it's connected via USB. You can see the sample rate of the playback on the second line of the Display while the USB Input is selected. The sample rate is affected by the audio source, the software used for playback, and the Settings set in the McIntosh HD Control Panel software.



## Installing the Software:

*Note: The software must be installed before connecting the MA9500 to a Windows computer via USB. If you are using an Apple computer, installing the software drivers are not necessary; however, if you'd like to install the McIntosh HD Control Panel software, you can follow the same steps.*

To control and play audio through the MA9500 from a Windows computer, you will need to download and install the software drivers to your computer first. You can find all the software at the following webpage:

<https://www.mcintoshlabs.com/products/integrated-amplifiers/MA9500>

The download package includes the software drivers as well as the McIntosh HD Control Panel software. Under the "Downloads" section near the bottom of the product page, click the down arrow to expand, locate the software download link appropriate for your system, and click it to start the download. Navigate to the download location on your computer, find the .zip file containing the software, and extract it to a new folder. In the new folder with the extracted contents, find the install file, open it, and follow the on-screen prompts to install the software. Once installed, reboot your computer, and the drivers and the McIntosh HD Control Software will be installed. You are now free to connect your computer to the MA9500 via the USB Audio port on the rear panel and control it using the installed software.

If you are experiencing trouble getting audio from the MA9500 via USB, check your Output Settings on your computer to make sure the MA9500 is recognized and ready for playback.

---

## Frequently Asked Questions

---

### **Q: What are the Jumper Plugs for? Why use them?**

A: The MA9500 is an all-in-one integrated amplifier, equipped with the capabilities of both a preamplifier and a power amplifier. With the Jumper Plugs connecting the Output 1 and PWR AMP ports, your device will preamplify and amplify your sound through Output 1. To allow greater flexibility with a wide variety of sound systems, we enabled the ability to remove the Jumper Plugs to use the MA9500 as a dedicated preamplifier without the power amplifier functionality. See "Using External Power Amplifiers" on Page 16 for details.

### **Q: What is the difference between Fixed Output and a regular Output?**

A: A regular Output is designed to be used for listening. Sound from regular Outputs will behave as anticipated -- adjusting the Equalizer or Volume, for example, will affect it appropriately. A Fixed Output is designed for recording devices. No adjustments can be made to sound coming from the Fixed Outputs, allowing you to listen to and adjust sound coming from the regular Outputs while knowing sound coming from your Fixed Outputs (and into a recording device) remains unaltered, meaning your recording source will be consistent.

### **Q: When I press the Input Control Knob, it isn't doing what I expect. What's wrong?**

A: The Input Control Knob is designed to be pressed or held to activate various functions. To prevent unintended or incorrect Knob presses, we have implemented several ways a press can be read by the unit:

Deliberate Press: This is a press that is longer than a "Tap," but not long enough to be considered a "Hold." Pushing in deliberately will open the Trim Functions Menu and act as a "back" function while inside of most menus.

Press and Hold: Push the Knob in deliberately and hold it down for a couple of seconds to initiate a "Hold." This will open the Trim Functions Menu or navigate further down into Submenu when a "Hold Input" prompt is displayed. Be sure not to hold down for too long or you may initiate service features. If you do, do a Deliberate Press to back out.

Tap: An extremely brief press of the Knob is considered a "Tap." To prevent accidental commands from being registered, a "Tap" serves no function for the MA9500 and will not do anything.

Try altering the way you are pressing the Knob to see if that helps. If you feel that Knob presses are not working as intended, try resetting the microprocessors using the method described in the Note section under "Using Your MA9500" on Page 15.

### **Q: What is the difference between a Balanced and Unbalanced signal?**

A: Balanced signals are able to split and replicate an audio source's signal, which allows it to travel a large distance without any noise or distortion. You will use these Inputs when you need to run a very long cord to another location. Unbalanced signals are used for short distances, so they do not require this functionality. Use Unbalanced Inputs to run short cords between devices that are close together and you won't run into any noise or distortion issues.

---

## Preamplifier Specifications

---

### Frequency Response

+0, -0.5dB from 20Hz to 20,000Hz

+0, -3dB from 10Hz to 100,000Hz

### Preamplifier Output 1 and 2 (for rated input)

1.7V unbalanced (8V Maximum)

3.4V balanced (8V Maximum)

### Preamplifier Output Impedance

220 ohms

### Sensitivity (for rated output)

High Level - 300mV unbalanced

600mV balanced

Phono MM, 3.0mV

Phono MC, 0.3mV

### Signal To Noise Ratio (A-Weighted)

High Level, 98dB below rated output

Phono MM, 84dB below 5mV input

Phono MC, 82dB below 0.5mV input

### Input Impedance

High Level - 22K ohms Unbalanced

44k ohms Balanced

Phono MM - 50 to 400pF, in 50pF steps;

47K ohms

Phono MC - 50, 100, 200, 400 or 1,000 ohms;

100pF

### Maximum Input Signal

High Level, 8V unbalanced, 16V balanced

Phono MM, 80mV

Phono MC, 8mV

### Headphone Impedance

100 to 600 ohms

### Equalizer Controls

25Hz, 50Hz, 100Hz, 200Hz, 400Hz, 1,000Hz, 2,500Hz and

10,000Hz

---

## Power Amplifier Specifications

---

### Power Output

Minimum Output Power Per Channel:

300W into 2, 4, or 8-Ohm speaker load

### Output Load Impedance

2, 4 or 8 ohms

### Rated Power Band

20Hz to 20,000Hz

### Total Harmonic Distortion

0.005% maximum with both channels operating from 250 milliwatts to rated power, 20Hz to 20,000Hz

### Intermodulation Distortion

0.005% maximum, if the instantaneous peak power output does not exceed twice the rated power output for any combination of frequencies from 20Hz to 20,000Hz.

### Dynamic Headroom

2.8dB

### Wide Band Damping Factor

Greater than 40

### Power Guard

Less than 2% THD with up to 16dB overdrive at 1,000Hz

### Frequency Response

+0, -0.25dB from 20Hz to 20,000Hz

+0, -3.0dB from 10Hz to 100,000Hz

### Input Sensitivity (for rated output)

1.7 Volts

### Signal To Noise Ratio (A-Weighted)

114dB below rated output

### Input Impedance

22,000 ohms

### Maximum Input Signal

Power Amplifier In, 16V

### Voltage Gain

29dB, 8 Ohms

26dB, 4 Ohms

23dB, 2 Ohms

### Power Control and Trigger Output

12VDC, 25mA

---

## Digital Audio Specifications

---

### Digital Input Signal Format

Coaxial and Optical Inputs - SPDIF (PCM)

MCT and USB Inputs - PCM, DSD

### Digital Input Sample Rates

Optical: PCM - 16Bit, 24Bit - 44.1kHz to 192kHz

Coaxial: PCM -16Bit, 24Bit - 44.1kHz to 192kHz

MCT: PCM, SACD, -16Bit, 24Bit - 44.1kHz to 192kHz

USB: PCM - 16Bit, 24Bit, 32Bit - 44.1kHz to 384kHz

DXD - DXD352.8kHz, DXD384kHz

DSD - DSD64, DSD128, DSD256, DSD512

HDMI: PCM 24bit, 44.1kHz - 192kHz

DTS

Dolby Digital

### Digital Inputs

Coaxial: 0.5V p-p/75 ohms

Optical: -15dbm to -21dbm (TOS Link)

MCT: 0.5V p-p/75 ohms

USB: USB Type B Connector

HDMI

### Representative Equalizer Boost/Cut Frequency Response

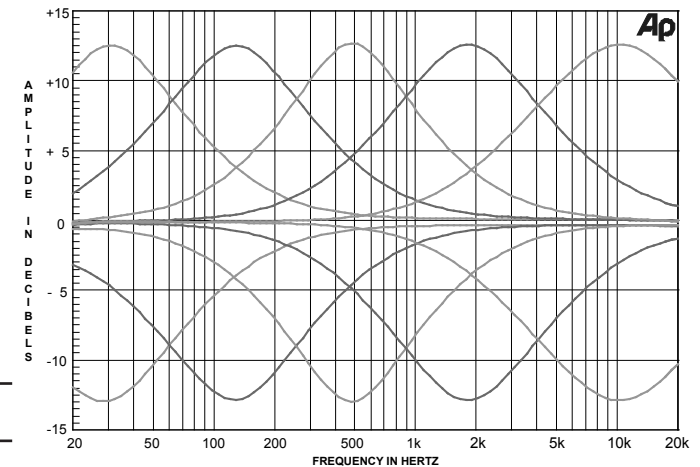

## General Specifications

**Power Control and Trigger Output**  
12VDC, 25mA

### Power Requirements

*Field AC Voltage conversion of the MA9500 is not possible.*

*The MA9500 is factory configured for one of the following AC Voltages:*

100 Volts, 50/60Hz at 8.0 amps  
110 Volts, 50/60Hz at 6.6 amps  
120 Volts, 50/60Hz at 6.6 amps  
127 Volts, 50/60Hz at 6.6 Amps  
220 Volts, 50/60Hz at 3.6 amps  
230 Volts, 50/60Hz at 3.3 amps  
240 Volts, 50/60Hz at 3.3 amps  
Standby: Less than 0.25 watt

*Note: Refer to the rear panel of the MA9500 for the correct voltage.*

### Overall Dimensions

Width is 17-1/2 inches (44.45cm)  
Height is 9-7/16 inches (24.0cm) including feet  
Depth is 19-3/4 inches (50.16cm) including the Front Panel and Knobs

### Weight

101 pounds (45.8 kg) net, 134 pounds (60.8 kg) in shipping carton

### Shipping Carton Dimensions

Width is 29-1/2 inches (74.93cm)  
Depth is 29 inches (73.66cm)  
Height is 17 inches (43.18cm)

## Packing Instructions

In the event it is necessary to repack the equipment for shipment, the equipment must be packed exactly as shown below. It is very important that the four plastic feet are attached to the bottom of the equipment. Two 1/4-20 x 2-1/4 inch screws and washers must be used to fasten the unit securely to the bottom pad and wood skid. This will ensure the proper equipment location on the bottom pad. Failure to do this will result in shipping damage.

Use the original shipping carton and interior parts only if they are all in good serviceable condition. If a shipping carton or any of the interior part(s) are needed, please call or write Customer Service Department of McIntosh Laboratory. Refer to Page 3. Please see the Part List for the correct part numbers.

## MA9500 Packing Material List

Quantity	Part Number	Description
1	034052	Shipping carton top
1	034051	Shipping carton bottom
2	034186	Front and rear foam pad
2	034187	Side foam pad
2	034054	Top and bottom foam pad
1	034136	Inner carton top
1	034137	Inner carton bottom
1	034188	Inner foam pad
1	034479	Shipping skid
4	401212	1/4-20 hex cap x 2-1/4 inch screw
2	104058	1/4 inch flat washer 1-1/2 inch
4	017937	Plastic foot
4	404080	#10 flat washer

