

ONIX

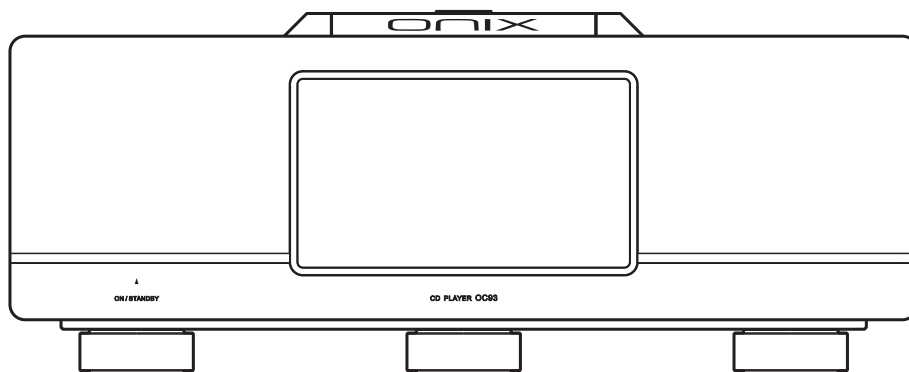

OWNER'S MANUAL

OC93

CD PLAYER



Notices for Use

CAUTION: RISK OF ELECTRIC SHOCK. DO NOT OPEN.	
	<p>The lightning flash with an arrowhead symbol within an equilateral triangle is intended to alert the user to the presence of un-insulated dangerous voltage within the product's enclosure which may be of sufficient magnitude to constitute a risk of electric shock.</p>
	
	<p>The exclamation point within an equilateral triangle is intended to alert the user to the presence of important operating and maintenance (servicing) instructions in the literature accompanying the product.</p>

1. Do not open this device yourself to repair or modify it. You should never attempt to service the product beyond that described in this manual. All other servicing should be referred to qualified service personnel. Opening this device or attempting to carry out any modification without approval may affect the performance or quality of this device.
2. For good ventilation, a minimum of 10cm clearance shall be maintained at the back and two sides and 20cm at the top of the unit.
3. Allow no water dripping or splashing into the unit. Place no object containing liquid on the unit, e.g. Vase.
4. Do not cover any ventilation hole with newspaper, cloth, curtain, etc. in case of ventilation blocking.
5. Allow no exposed flame source on the unit, e.g. burning candle.
6. The unit shall be connected to AC power output socket with grounding protection.
7. If power plug and appliance coupler are used as disconnecting device, the disconnecting device shall be easily operable.
8. Any batteries requiring disposal must be handled in accordance with local regulations.
9. This device is intended for safe use in an area with elevation under 2000m. (Fig.1)
10. This device is intended for safe use under non-tropical climate conditions. (Fig.2)

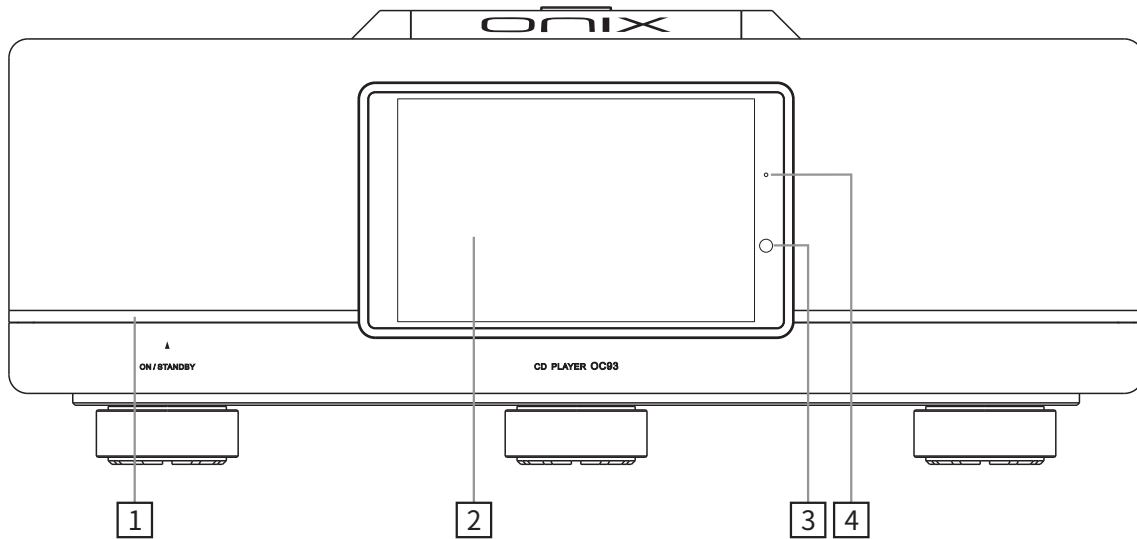

Fig.1



Fig.2

Names of Parts



1. Touch sensitive power switch
2. Touch screen

3. Remote control receiving window
4. Standby indicator light

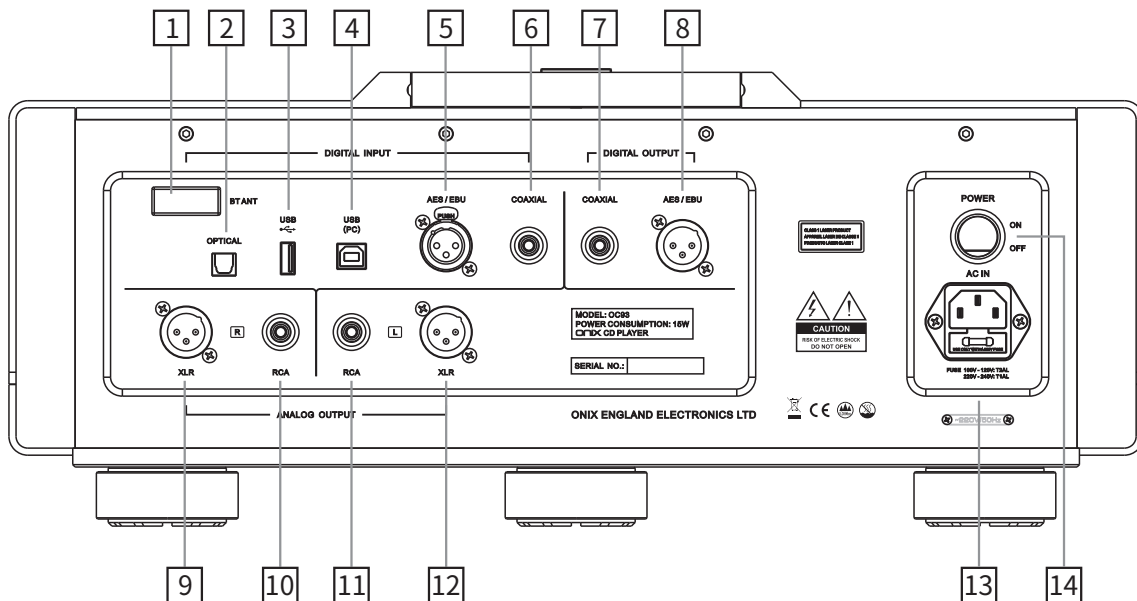

1. Bluetooth antenna
2. Optical fiber digital signal input
3. USB drive input connector
4. USB B connector for PC connection
5. AES/EBU digital signal input
6. Coaxial digital signal input
7. Coaxial digital signal output

8. AES/EBU digital signal output
9. XLR right sound channel audio output
10. RCA right sound channel audio output
11. RCA left sound channel audio output
12. XLR left sound channel audio output
13. AC input socket (fuse attached)
14. Power switch button

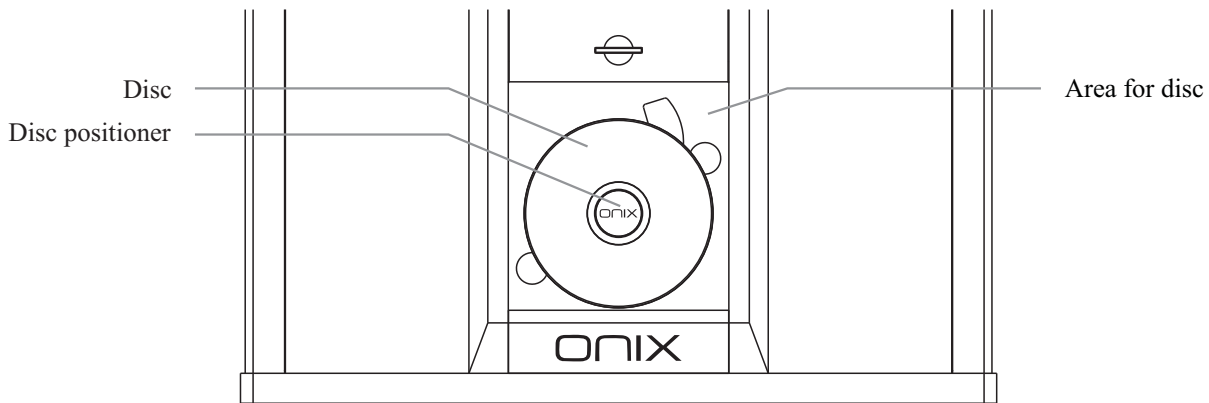

Notes on playing the disc:

After placing the disc into the disc area, you should press it into the disc positioner, and close the disc door, and press the PLAY button. Then the disc will start to play.

Remote Control Diagram

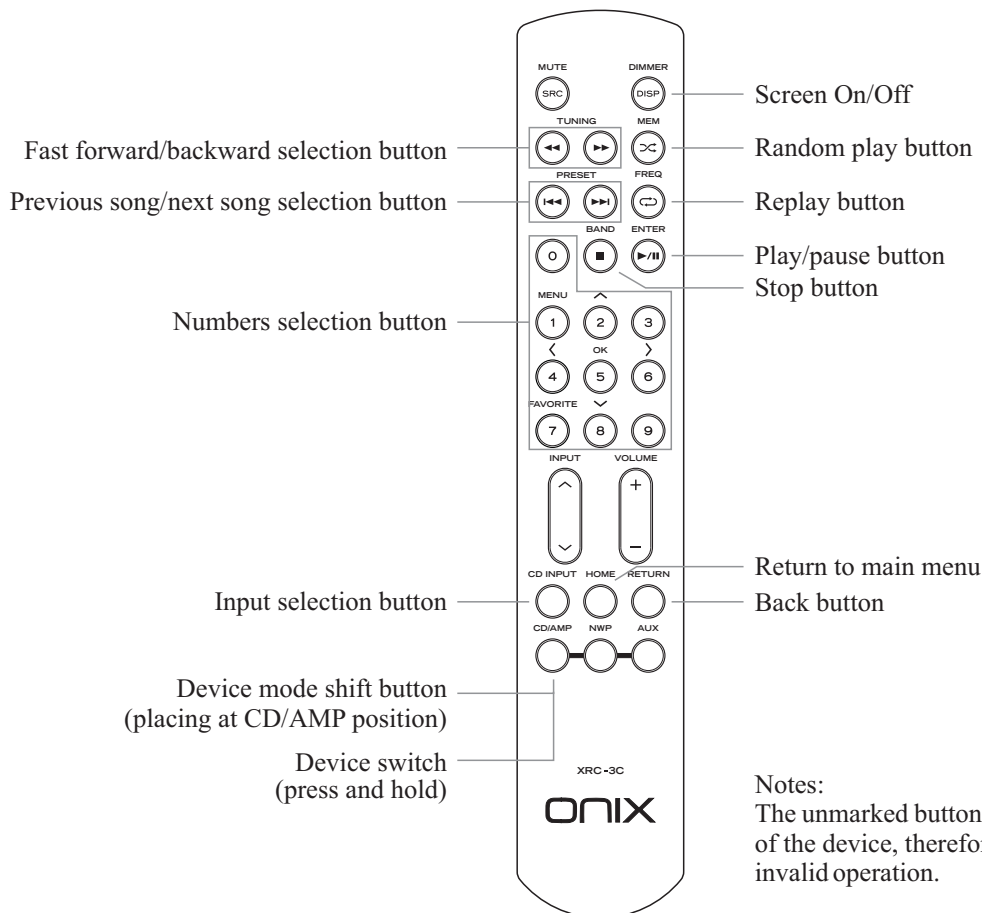

Notes:
The unmarked button are not functional buttons of the device, therefore pressing those button is invalid operation.

Install Battery

1. Open the battery cover.
2. Insert 2 AAA batteries and check the positive and negative polarity of the batteries is correct.
3. Close the battery cover.

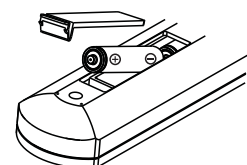

Operation Instructions

Preparations

1. Connect power and signal cables to the device, then turn the power switch to “ON” position. Indicator light on front panel will light up red. Now touch the “ON/Standby” on front panel to turn on the device. On your remote, you can hold down the “CD/AMP” button to turn on the device. Indicator light on front panel turns blue when device turns on.
2. To turn off the device, Hold down your finger on the “ON/Standby” or press and hold down the “CD/AMP” button on your remote. Confirm shutdown on the touch screen. Device turns into standby mode, with red indicator light on front panel. Switch the power switch on rear to “OFF” position to completely turn off the device.
3. Screen can be turned on/off by pressing the “Dimmer” button on remote.
4. If the device will not be used for a long time, please unplug the AC power line connected to the device.

Gesture / Floating Ball Operation

1. Gesture mode (Settings - System Settings - Display - Virtual Key Mode)
Return to the previous: slide to the right from the left edge of the screen or slide to the left from the right edge of the screen.
Back to the main screen: slide up from the bottom of the screen.
2. Floating ball mode (Setting - System Settings - Display - Virtual Key Mode)
Return to the previous: click the floating ball on the screen.
Back to the desktop: press and hold the floating ball on the screen.

Input Switching

Go to “Input Switching” on the device or press “CD INPUT” on remote to switch between different inputs:

CD — Local Play — USB_DAC — BLUETOOTH — COAXIAL — OPTICAL — AES/EBU

Disc play/Pause

1. Move the disc cover backward and open it, put the disc onto the disc area and press it into the disc positioner, and draw the disc cover forward and close it.
2. Select the “CD Play” on screen, it will show total amount of tracks and total length.
3. Click on the “▶” or press “▶/||” button on remote to start playback.
4. Click on the “||” or press “▶/||” button on remote to pause playback.

Stop

1. Click on the “■” on device or remote to stop playback.
2. Before changing disc, please stop playback by pressing the “■”.

Previous song/Next song

1. Click on the “◀” or press “◀◀” button on remote to skip to previous track.
2. Click on the “▶” or press “▶▶” button on remote to sip to next track.

Fast forward/backward

1. When it is playing normally, press and hold the “◀◀” button on the remote control, it is fast backward search. When no button is pressed or held, it is normal playing condition.
2. When it is playing normally, press and hold the “▶▶” button on the remote control, it is fast forward search. When no button is pressed or held, it is normal playing condition.

Replay

To activate replay for current track, tap the “◻” on device or “↺” on remote. Tap the “↻” on device or “↺” on remote again to activate replay for the whole album. Tap the “◻” on device or “↺” on remote again to turn off the replay function.

Selection of the songs

If you want to select songs from number 1 to 9, just press the buttons on the remote control. If you want to select a song numbered 10 or more, you should press the number from the left to right. For example, if you want to select a song numbered 12, you should press 1, then press 2.

Random play

1. To activate random play, tap the “⊗” on device or “⋈” on remote. Icon will change to “⊗”. Playback will run until all tracks were played.
2. To deactivate random play, tap the “⊗” on device or “■” on remote.

Bluetooth Input

1. Switch the input to “BLUETOOTH” mode.
2. Open Bluetooth settings on your device and search for new devices.
3. Amplifier will show up as “ONIX OC93” .
4. Pair it with your device and let it connect.

USB DAC Setting

1. Connect the USB cable from PC to the rear panel of the unit.
2. Go to “Input Switching” or use “CD INPUT” button on remote to switch to “USB_DAC” input.
3. Install the driver software into the PC from the “USB driver disc” .
4. Setup the “SOUND” option on the PC, set the “Speaker XMOS USB Audio” as the default device.

WiFi File Transfer

Go to Settings - WiFi File transfer on your device to enable WiFi File transfer. Follow instructions on the display. Make sure device and your computer are connected to the same network.

Firmware Update

Do not do operate the player during the update process.

Over-the-Air Update

1. Turn on Wi-Fi and connect to local network.
2. Go to Settings – Firmware Update – Online Update.
3. Confirm installation and wait until process finishes.

Local Update

1. Please download firmware update . Copy the latest firmware file onto the Internal Storage or External Storage.
2. Go to “Settings - Firmware Update - Local Update” , choose the path to firmware file and click update.

Companion APP

Eddict Player app allows access to additional settings and control over OC93. You can download it from Play store or Apple Store.

DLNA Playback – Go to Settings – DLNA and turn on “DLNA Service”. In Eddict Player app, go to “Device Resources” and select “ONIX OC93”.

Wireless Control – Go to Settings – Wireless Projection and turn it on. In Eddict Player app, go to side menu, pick “Wireless Projection” and select “ONIX OC93”.

Note: Device and phone needs to be connected to same WiFi network.



Technical Specification

Balanced analog output level	5.0V
Unbalanced analog output level	2.5V
Frequency response	20Hz-40kHz (-0.5dB)
THD	<0.0008%
SNR	>117dB
Dynamic range	>117dB
USB drive playback	32bit/768kHz; DSD512
USB DAC input	USB2.0; 32bit/768kHz
USB DAC DSD compatibility	DSD64; DSD128; DSD256
Wireless connection	Bluetooth 5.0
Power consumption	15W
Standby power consumption	<1W
Dimension (W × D × H)	480 × 394 × 192mm
Net weight	About 20.2kg

Accessories

User manual	Remote control
Power source line	Disc positioner
USB line	USB drive disc

使用注意事项

		注意：为防电击，请勿打开机盖。
		等边三角形中有箭头闪电符号的图形表示警告使用者在产品内有高压电，会导致人为的触电。
		等边三角形中有叹号的图形表示警告使用者该设备有重要的操作和维护指示。

1. 不可自行开启本机进行维修或改造！本产品不设有用户自行检修的零件，本机的维修须请具备专业资格的人员进行。开启机器及随意改造内部电路会令检修人员难以维修本机，而且会对机器造成性能或质量的影响。
2. 为了充分通风，设备背面和两侧应最少保留10cm，顶部应最少保留20cm的空间。
3. 设备不应遭受水滴或水溅，机器上不应放置诸如花瓶一类的装满液体的物品。
4. 通风孔不要覆盖诸如报纸、桌布和窗帘等物品而妨碍通风。
5. 设备上不要放置裸露的火焰源，如点燃的蜡烛。
6. 设备应当连接到带保护接地连接的电网电源输出插座上。
7. 用电源插头和器具耦合器作为断开装置，断开装置应当保持能方便地操作。
8. 必须遵照电池废弃的相关地方条例来废弃旧电池。
9. 仅适用于海拔2000m以下地区安全使用，标志见图1。
10. 仅适用于非热带气候条件下安全使用，标志见图2。



图1



图2

部件名称

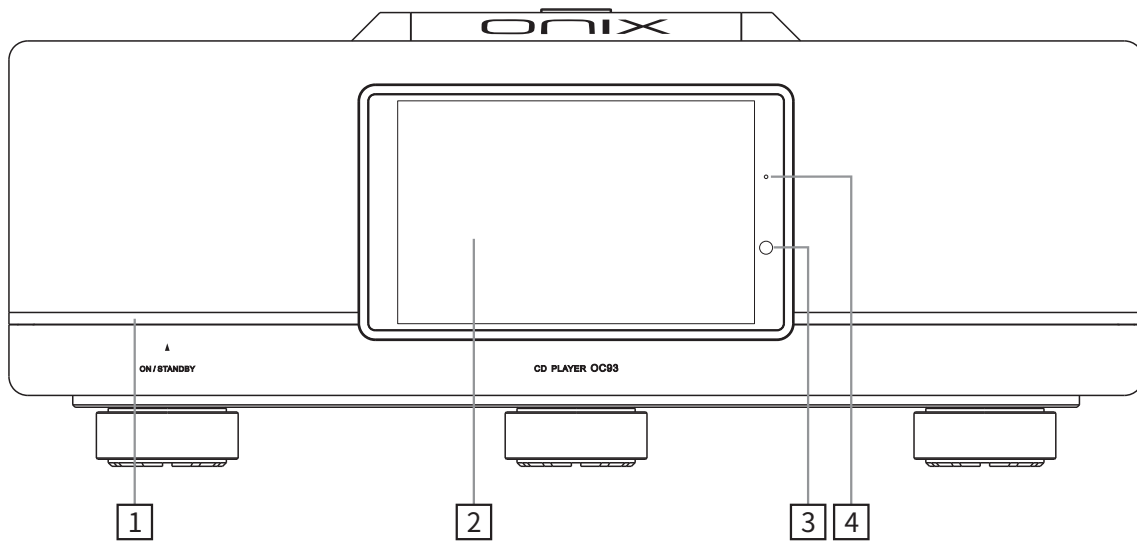

1. 触摸开关
2. 触摸显示屏

3. 遥控接收窗口
4. 待机指示灯

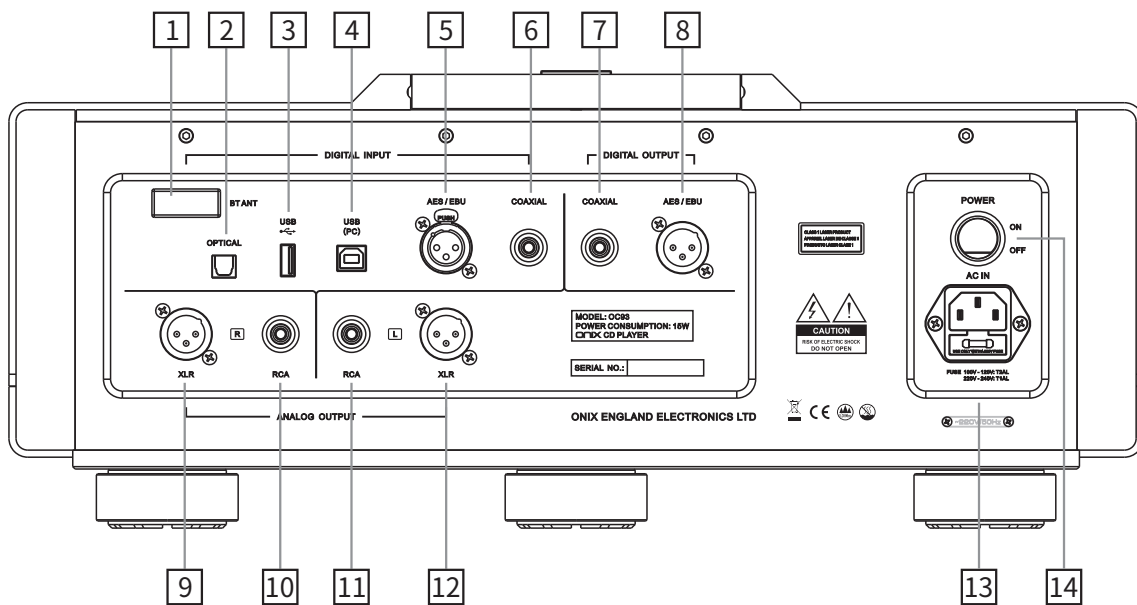

1. 蓝牙天线
2. 光纤数字信号输入接口
3. U盘接口
4. USB(PC)接口
5. 平衡数字信号输入接口
6. 同轴数字信号输入接口
7. 同轴数字信号输出接口

8. 平衡数字信号输出接口
9. XLR右声道音频输出接口
10. RCA右声道音频输出接口
11. RCA左声道音频输出接口
12. XLR左声道音频输出接口
13. 交流电源输入插座(带保险管)
14. 电源开关键

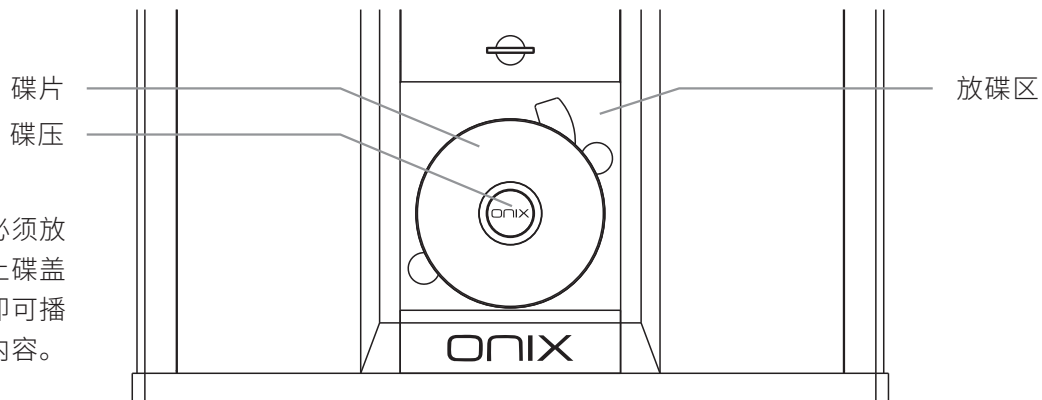

播放注意：
放入碟片后必须放上碟压并关上碟盖后按播放键即可播放碟片曲目内容。

遥控器示意图

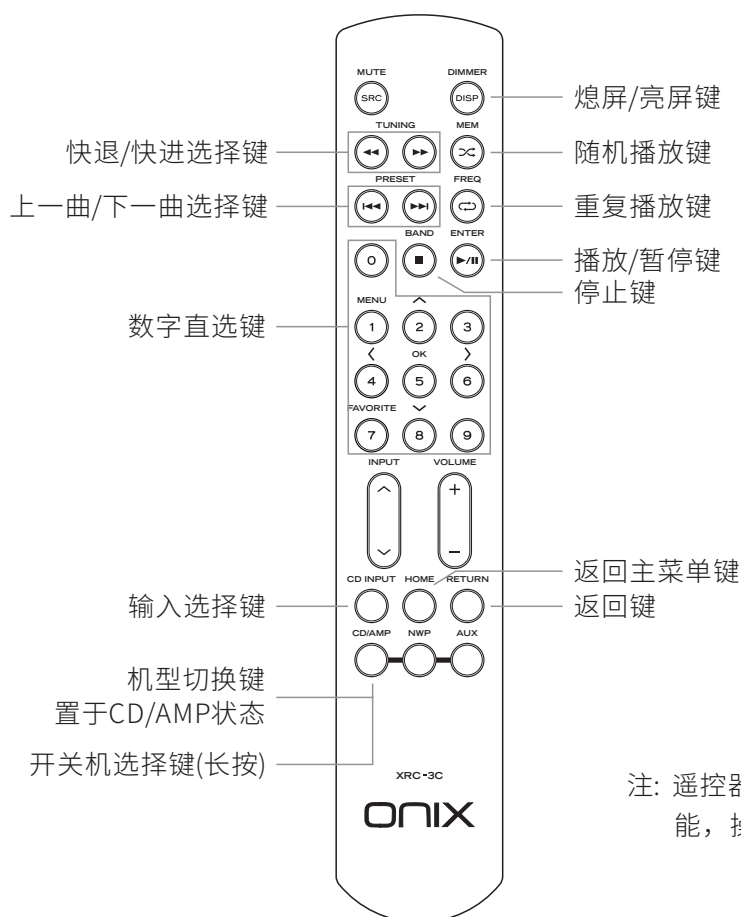

注：遥控器未标示按键非本机功能，操作无效属正常现象。

电池安装

1. 打开电池盖。
2. 装入两节七号电池，确认电池正负极安装正确。
3. 盖上电池盖。

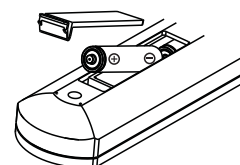

操作说明

准备工作

1. 首先连接好机器的电源及信号线，再将后板上的电源开关置于“ON”位置，面板上的指示灯点亮为红色，此时可触摸面板左侧“ON/STANDBY”金属条(1秒以上)或长按遥控器上的“CD/AMP”键，指示灯变为蓝色，机器进入正常工作状态。
2. 要关闭本机电源时，触摸面板左侧“ON/STANDBY”金属条(1秒以上)或长按遥控器上的“CD/AMP”键，显示屏显示“关机”和“重启”选择窗口，点击“关机”关闭机器，指示灯变为红色，此时机器处于待机状态，再将后板上的电源开关置于“OFF”位置即可关闭本机电源。
3. 在开机状态下，按遥控器上的“DIMMER”键可进行熄屏、亮屏操作。
4. 若长时间不使用本机，请将与机器连接的交流电源线插头拔下。

手势/悬浮球操作

1. 手势模式（设置-系统设置 - 显示 - 虚拟键模式）
返回上一级：从屏幕左侧边缘向右滑或右侧边缘向左滑。
返回桌面：从屏幕下方向上滑。
2. 悬浮球模式（设置-系统设置 - 显示 - 虚拟键模式）
返回上一级：在屏幕上单击悬浮球。
返回桌面：在屏幕上长按悬浮球。

音源切换

在触摸屏上选择“音源切换”或遥控器上的“CD INPUT”键，显示屏上显示如下：

CD — 本地播放 — USB_DAC — 蓝牙 — COAXIAL — OPTICAL — AES/EBU

碟片播放/暂停

1. 先把碟盖向后推动打开，把碟片放在放碟区上并放上碟压，再将碟盖向前拉动关闭。
2. 在触摸屏上选择“CD播放”，显示屏显示碟片的总曲目和总时间。
3. 在触摸屏播放界面上点击“▶”或遥控器上的“▶/||”键即可播放碟片上的所有内容。
4. 播放状态下，在触摸屏播放界面上点击“||”或遥控器上的“▶/||”键，可对当前碟片进行暂停播放。

停止

1. 在播放状态下，点击触摸屏或遥控器上的“■”键，可停止当前碟片的播放。
2. 在播放状态下，当想更换碟片时，请先点击触摸屏或遥控器上的“■”键，停止当前碟片的播放，再打开碟盖。

上一曲/下一曲

1. 在正常播放时，点击触摸屏“◀”或遥控器上的“◀◀”键即可跳向上一曲进行播放。
2. 在正常播放时，点击触摸屏“▶”或遥控器上的“▶▶”键即可跳向下一曲进行播放。

快退/快进

1. 在正常播放时，按住遥控器上的〈◀◀〉键即可快速向后搜索，放开该键时恢复正常播放状态。
2. 在正常播放时，按住遥控器上的〈▶▶〉键即可快速向前搜索，放开该键时恢复正常播放状态。

重复播放

重复播放单前曲目内容，点击触摸屏“⏮”或遥控器上的“⏮”键一次，显示屏图标变为“⏮”。重复播放整张碟片曲目内容，点击触摸屏“🔄”或再按一次遥控器上的“⏮”键，显示屏图标变为“🔄”。取消重复播放功能，点击触摸屏“🔄”或再按一次遥控器上的“⏮”键，显示屏图标变为“⏮”。

选曲

选第1至第9首曲目，可以直接按遥控器上的1至9数字键。选10首或以上曲目先按十位数对应的数字键，再按个位数字对应数字键。如：选12首曲目，先按数字键1，再按数字键2即可。

随机播放

1. 在停止或播放状态下，点击触摸屏“⊗”或遥控器上的“⊗”键，显示屏图标变为“⊗”，表示已在开始执行随机播放功能。随机播放功能是随碟机自动播放碟片曲目内容直至全部播放完毕。
2. 在执行随机播放过程中如想取消该功能，点击触摸屏“⊗”或遥控器上的“■”键即可。

Bluetooth 输入

1. 将信号源切换到“蓝牙”状态。
2. 此时本机蓝牙会一直处于可以被搜索状态，打开手机或iPad等搜索蓝牙设备。
3. 在搜索到的设备中选择“ONIX OC93”。
4. 设备连接好后，使用播放软件播放音乐即可。

USB设置

1. 将USB电缆从电脑连接到机器后板上。
2. 打开机器并在主界面选择“音源切换”或遥控器上的“CD INPUT”键，选择到对应的“USB_DAC”输入信号。
3. 将随机附带的“USB驱动光盘”安装到电脑上。
4. 将电脑的“声音”选项进行设置，并把“扬声器 XMOS USB Audio”勾选为默认设备。

WIFI传歌

在主界面选择“设置 - 播放设置 - WIFI传歌”即可进行操作（设备与电脑连接需在同一个WIFI下）。

固件升级

升级过程中请不要操作机器。

OTA在线升级

1. 打开WiFi功能并连接到可用网络。
2. 前往“设置 - 固件升级 - 在线升级”即可自动检查更新。
3. 如检测到有新版本，点击“继续更新”开始下载，再点击“安装更新”直到安装完成即可。

本地升级

1. 请下载固件升级程序，将新固件拷贝到机器“内置存储”或“外置存储”上，建议升级文件放置在根目录下。
2. 前往“设置 - 固件升级 - 本地升级”，进入存放固件的路径并选择相应的固件点击升级。

APP控制

扫描二维码并对应下载“Eddict Player”APP，安装完成后即可对产品进行操控。

方法1：前往设备“设置 - 播放设置 - DLNA”并将“DLNA服务”开关打开，再打开手机端的“Eddict Player”APP主界面，在“设备资源”里选择“ONIX OC93”即可对产品进行操控。

方法2：前往设备“设置 - 播放设置 - 无线投屏”并将“无线投屏”开关打开，再打开手机端的“Eddict Player”APP主界面，点击左上角的“≡”图标，在“无线投屏”里选择“ONIX OC93”即可对产品进行操控。

注：设备与手机连接需在同一个WIFI下。



Eddict Player
扫码即可下载

技术规格

平衡模拟输出电平	5.0V
非平衡模拟输出电平	2.5V
频率响应	20Hz-40kHz (-0.5dB)
谐波失真	<0.0008%
信噪比	>117dB
动态范围	>117dB
U盘播放	32bit/768kHz; DSD512
USB接收器规格	USB2.0; 32bit/768kHz
DSD信号规格	DSD64; DSD128; DSD256
蓝牙标准	Bluetooth 5.0
消耗功率	15W
待机功率	<1W
体积 (宽×深×高)	480×394×192mm
净重	约 20.2kg

随机附件

用户手册	遥控器
电源线	碟压
USB线	USB驱动光盘



ONIX ENGLAND ELECTRONICS LTD



Due to continuous improvement, every specification and design is subject to change at any time without further notice.

由于产品不断改进，各项规格及设计随时更改，恕不另行通知。