

**A T H E M**<sup>®</sup>

**MRX 1140 / 740 / 540**

A/V RECEIVER

**AVM 90 / 70**

A/V PROCESSOR



**OPERATING MANUAL**

# SAFETY PRECAUTIONS



## CAUTION

RISK OF ELECTRIC SHOCK DO NOT OPEN



**CAUTION: TO REDUCE THE RISK OF ELECTRIC SHOCK, DO NOT REMOVE COVER (OR BACK). NO USER-SERVICEABLE PARTS INSIDE. REFER SERVICING TO QUALIFIED SERVICE PERSONNEL**

THE LIGHTNING FLASH WITH ARROWHEAD SYMBOL WITHIN AN EQUILATERAL TRIANGLE IS INTENDED TO ALERT THE USER TO THE PRESENCE OF UNINSULATED "DANGEROUS VOLTAGE" WITHIN THE PRODUCT'S ENCLOSURE THAT MAY BE OF SUFFICIENT MAGNITUDE TO CONSTITUTE A RISK OF ELECTRIC SHOCK TO PERSONS.

THE EXCLAMATION POINT WITHIN AN EQUILATERAL TRIANGLE IS INTENDED TO ALERT THE USER TO THE PRESENCE OF IMPORTANT OPERATING AND MAINTENANCE (SERVICING) INSTRUCTIONS IN THE LITERATURE ACCOMPANYING THE APPLIANCE.

**WARNING:** TO REDUCE THE RISK OF FIRE OR ELECTRIC SHOCK, DO NOT EXPOSE THIS APPARATUS TO RAIN OR MOISTURE, AND OBJECTS FILLED WITH LIQUIDS, SUCH AS VASES, SHOULD NOT BE PLACED ON THIS APPARATUS.

**CAUTION:** FOR CONTINUED PROTECTION AGAINST RISK OF FIRE, REPLACE THE FUSE ONLY WITH THE SAME AMPERAGE AND VOLTAGE TYPE. REFER REPLACEMENT TO QUALIFIED SERVICE PERSONNEL.

**CAUTION:** TO PREVENT ELECTRIC SHOCK, MATCH WIDE BLADE OF PLUG TO WIDE SLOT, FULLY INSERT.

**WARNING:** UNIT MAY BECOME HOT. ALWAYS PROVIDE ADEQUATE VENTILATION TO ALLOW FOR COOLING. DO NOT PLACE NEAR A HEAT SOURCE, OR IN SPACES THAT CAN RESTRICT VENTILATION.

## IMPORTANT SAFETY INSTRUCTIONS:

1. Read these instructions.
2. Keep these instructions.
3. Heed all warnings.
4. Follow all instructions.
5. Do not use this apparatus near water.
6. Clean only with a dry cloth.
7. Do not block any of the ventilation openings. Install in accordance with the manufacturer's instructions.
8. Do not install near any heat sources such as radiators, heat registers, stoves or other apparatus (including amplifiers) that produce heat.
9. Do not defeat the safety purpose of the polarized or grounding-type plug. A polarized plug has two blades with one wider than the other. A grounding-type plug has two blades and a third grounding prong. The wide blade or the third prong is provided for your safety. When the provided plug does not fit into your outlet, consult an electrician for replacement of the obsolete outlet.
10. Protect the power cord from being walked on or pinched, particularly at plugs, convenience receptacles and the point where they exit from the apparatus.
11. Only use the attachments/accessories specified by the manufacturer.
12. Use only with a cart, stand, tripod, bracket or table specified by the manufacturer, or sold with the apparatus.
13. When a cart is used, use caution when moving the cart/apparatus combination to avoid injury from tip-over.
14. Unplug this apparatus during lightning storms or when unused for long periods of time.
15. Refer all servicing to qualified service personnel. Servicing is required when the apparatus has been damaged in any way, such as power supply cord or plug is damaged, liquid has been spilled or objects have fallen into the apparatus, the apparatus has been exposed to rain or moisture, does not operate normally, or has been dropped.

## **WARENTY:**

To reduce the risk of fire or electric shock, do not expose this apparatus to rain or moisture. Avoid installing this unit where foreign objects may fall onto this unit and/or this unit may be exposed to liquid dripping or splashing. On the top of this unit, do not place:

- Burning objects (i.e. candles), as they may cause fire, damage to this unit, and/or personal injury.
- Containers with liquid in them, as they may fall and liquid may cause electrical shock to the user and/or damage to this unit.

Apparatus shall not be exposed to dripping or splashing and no objects filled with liquids, such as vases, shall be placed on the apparatus.

Do not install this equipment in a confined space such as a case or similar. Install it away from direct sunlight, heat sources, vibration, dust, moisture, and/or cold.

Do not cover this unit with a newspaper, tablecloth, curtain, etc. in order not to obstruct heat radiation. If the temperature inside this unit rises, it may cause fire, damage to this unit, and/or personal injury.

Install this unit near the AC outlet and where the AC power plug can be reached easily.

This unit is not disconnected from the AC power source when it is turned off. This state is called the standby mode. In this state, this unit is designed to consume a very small quantity of power.

## **NOTE:**

This product is not an auto voltage Amplifier. Connect only to the prescribed AC outlet, i.e., 120V 60Hz or 240V 50/60Hz.

## **CAUTION:**

Top surface can become hot.

## **CAUTION:**

These servicing instructions are for use by qualified service personnel only. To reduce the risk of electric shock, do not perform any servicing other than that contained in the operating instructions, unless you are qualified to do so.

## **CAUTION:**

Changes or modifications to this equipment not expressly approved by Paradigm Electronics for compliance could void the user's authority to operate this equipment.

## **FCC WARNING:**

Changes or modifications not expressly approved by the party responsible for compliance could void the user's authority to operate the equipment.

This equipment has been tested and found to comply with the limits for a class B digital device, pursuant to part 15 of the FCC Rules. These limits are designed to provide reasonable protection against harmful interference in a residential installation. This equipment generates, uses and can radiate radio frequency energy and, if not installed and used in accordance with the instructions, may cause harmful interference to radio communications. However, there is no guarantee that interference will not occur in a particular installation. If this equipment does cause harmful interference to radio or television reception, which can be determined by turning the equipment off and on, the user is encouraged to try to correct the interference by one or more of the following measures:

- Reorient or relocate the receiving antenna.
- Increase the separation between the equipment and amplifier.
- Connect the equipment into an outlet on a circuit different from that to which the amplifier is connected.
- Consult the dealer or an experienced radio / TV technician for help.

## IMPORTANT INFORMATION FOR UK CUSTOMERS:

DO NOT cut off the mains plug from this equipment. If the plug fitted is not suitable for the power points in your home or the cable is too short to reach a power point, then obtain an appropriate safety approved extension lead or consult your dealer. If, nonetheless, the mains plug is cut off, REMOVE THE FUSE and dispose of the PLUG immediately, to avoid possible shock hazard by inadvertent connection to the mains supply. If this product is not provided with a mains plug, or one has to be fitted, then follow the instructions given below:

IMPORTANT: DO NOT make any connection to the larger terminal which is marked with the letter "E" or by the safety earth symbol or colored GREEN or GREEN AND YELLOW.

The wires in the mains lead on this product are colored in accordance with the following code:

BLUE - NEUTRAL  
BROWN - LIVE

As these colors may not correspond with the colored markings identifying the terminals in your plug, proceed as follows:

The BLUE wire must be connected to the terminal marked with the letter "N" or colored BLACK.  
The BROWN wire must be connected to the terminal marked with the letter "L" or colored RED.

When replacing the fuse, only a correctly rated and approved type should be used, and be sure to re-fit the fuse cover. If in doubt consult a competent electrician.

## NOTES ON ENVIRONMENTAL PROTECTION:

At the end of its useful life, this product must not be disposed of with regular household waste but must be returned to a collection point for the recycling of electrical and electronic equipment. The symbol on the product, user's manual and packaging, point this out. The materials can be reused in accordance with their markings. Through re-use, recycling of raw materials or other forms of recycling of old products, you are making an important contribution to the protection of our environment. Your local administrative office can advise you of the responsible waste disposal point.

## RECYCLING AND REUSE GUIDELINES (Europe):

In accordance with the European Union WEEE (Waste Electrical and Electronic Equipment) directive effective August 13, 2005, we would like to notify you that this product may contain regulated materials which, upon disposal, require special reuse and recycling processing. For this reason Paradigm Electronics Inc. (the manufacturer of Paradigm speakers and Anthem electronic products) has arranged with its distributors in European Union member nations to collect and recycle this product at no cost to you. To find your local distributor please contact the dealer from whom you purchased this product or go to our website at [www.paradigm.com](http://www.paradigm.com).

Please note that only the product falls under the WEEE directive. When disposing of packaging and other shipping material we encourage you to recycle through the normal channels.

## INFORMATION ABOUT COLLECTION AND DISPOSAL OF WASTE BATTERIES (DIRECTIVE 2006/66/EC OF THE EUROPEAN PARLIAMENT AND THE COUNCIL OF EUROPEAN UNION)

(for European customers only)

Batteries bearing any of these symbols indicate that they should be treated as "separate collection" and not as municipal waste. It is encouraged that necessary measures are implemented to maximize the separate collection of waste batteries and to minimize the disposal of batteries as mixed municipal waste. End-users are exhorted not to dispose waste batteries as unsorted municipal waste. In order to achieve a high level of recycling waste batteries, discard waste batteries separately and properly through an accessible collection point in your vicinity. For more information about collection and recycling of waste batteries, please contact your local municipality, your waste disposal service or the point of sale where you purchased the items.

By ensuring compliance and conformance to proper disposal of waste batteries, potential hazardous effects on human health is prevented and the negative impact of batteries and waste batteries on the environment is minimized, thus contributing to the protection, preservation and quality improvement of the environment.

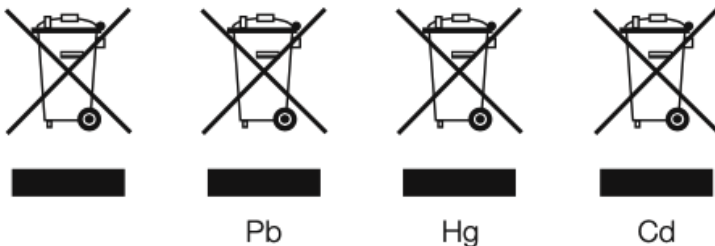

Anthem and any related party assume no liability for the user's failure to comply with any requirements.

# TABLE OF CONTENTS

## **1.0 BOX CONTENTS & PACKAGING**

### **1.1 Before Making Connections**

## **2.0 INTRODUCTION**

### **2.1 In-Use Notices**

### **2.2 Default Inputs**

### **2.3 Front Panel**

### **2.4 MRX 1140 Rear Panel**

### **2.5 MRX 740 Rear Panel**

### **2.6 MRX 540 Rear Panel**

### **2.7 AVM 90 Rear Panel**

### **2.8 AVM 70 Rear Panel**

### **2.9 Remote Control**

## **3.0 SPEAKER POSITIONING**

### **3.1 Speakers**

### **3.2 5.1-Channel Speaker Positioning**

### **3.3 7.1-Channel Speaker Positioning**

### **3.4 Height Effects Speaker Positioning**

## **4.0 CONNECTIONS**

### **4.1 HDMI Video Inputs And Outputs**

### **4.2 Audio Connections**

- 4.3** Local Area Network
- 4.4** 12 Volt Trigger
- 4.5** Infrared
- 4.6** RS-232
- 4.7** Power
- 4.8** Headphone Jack (Front Panel)

## **5.0 SETUP**

- 5.1** Speaker Setup
- 5.2** Bass Management
- 5.3** Listener Position
- 5.4** Level Calibration
- 5.5** Input Setup
- 5.6** Preferences
- 5.7** Network / Control
- 5.8** Store / Load / Update
- 5.9** System Info

## **6.0 ANTHEM ROOM CORRECTION**

- 6.1** Anthem Room Correction (ARC®)
- 6.2** Using ARC With An MRX/AVM

## **7.0 OPERATION**

- 7.1** Power On / Off and Volume
- 7.2** Zone 2 Operation
- 7.3** Input Selection

- 7.4** Level Trim
- 7.5** Bass / Treble / Balance
- 7.6** Lip-Sync
- 7.7** Listening Modes
- 7.8** Dolby Audio Post Processing and Dynamic Range Control
- 7.9** DTS:X Dialog Level Control
- 7.10** Display Brightness
- 7.11** Info Display
- 7.12** AirPlay SETUP
- 7.13** Chromecast SETUP

## LIMITED WARRANTY

# 1.0 BOX CONTENTS & PACKAGING

## 1.1 BEFORE MAKING CONNECTIONS

Check that you have received all items listed below and report discrepancies to your dealer as soon as possible. In case the unit needs to be transported in the future, keep the packing materials. Retain the invoice that you received from your authorized Anthem dealer at time of purchase - without it, service will not be provided under warranty.

- AVM Processor or MRX Receiver
- Remote Control
- 2x Wireless Network Antennas
- 2x AAA Batteries
- IEC Power Cord (US / UK / EU / CN types are supplied by factory, other types are normally provided by the local distributor)

Additional items in Anthem Room Correction (ARC) kit:

- USB Microphone
- Microphone Clip
- Telescopic Stand with Boom
- USB Cable

### **Save the Packaging**

Save your MRX/AVM's packaging. Should you move or should your unit require service, the original packaging will minimize the risk of damage during transport.



# 2.0 INTRODUCTION

## 2.1 IN-USE NOTICES

- Disconnect the power cord before connecting or disconnecting any components.
- If the MRX/AVM was transported or stored in the cold, let it reach room temperature before use.
- Due to continuing advances, operational characteristics may change. If this manual contains discrepancies, please check [www.AnthemAV.com](http://www.AnthemAV.com) for the latest manual or software.

## 2.2 DEFAULT INPUTS

Source	Audio Input	Video Input
HDMI 1	HDMI	HDMI 1
HDMI 2	HDMI	HDMI 2
HDMI 3	HDMI	HDMI 3
HDMI 4	HDMI	HDMI 4
HDMI 5	HDMI	HDMI 5
HDMI 6	HDMI	HDMI 6
HDMI 7	HDMI	HDMI 7
eARC	HDMI eARC	None
Streaming	Streaming	None
Bluetooth	Bluetooth	None
Optical 1	Optical 1	None
Coax 1	Coax 1	None
Analog 1	Analog 1	None

The unit comes programmed from the factory with thirteen (fourteen on AVM) inputs, but you may change this to create up to 30 inputs. MRX/AVM uses virtual inputs that give you complete control of the name of each input you create, along with which video (HDMI) input to use, which audio input (HDMI, digital, analog or streaming) to use, which speaker profile to use, and much more. You can even create multiple inputs for the same source device. For example, a Blu-ray input configured for 7.1.4-channels and another Blu-ray input configured for 2-channels (and no subwoofer). For information on setting up inputs, refer to the Setup section of this manual.

## 2.3 FRONT PANEL

MRX 1140 model shown.

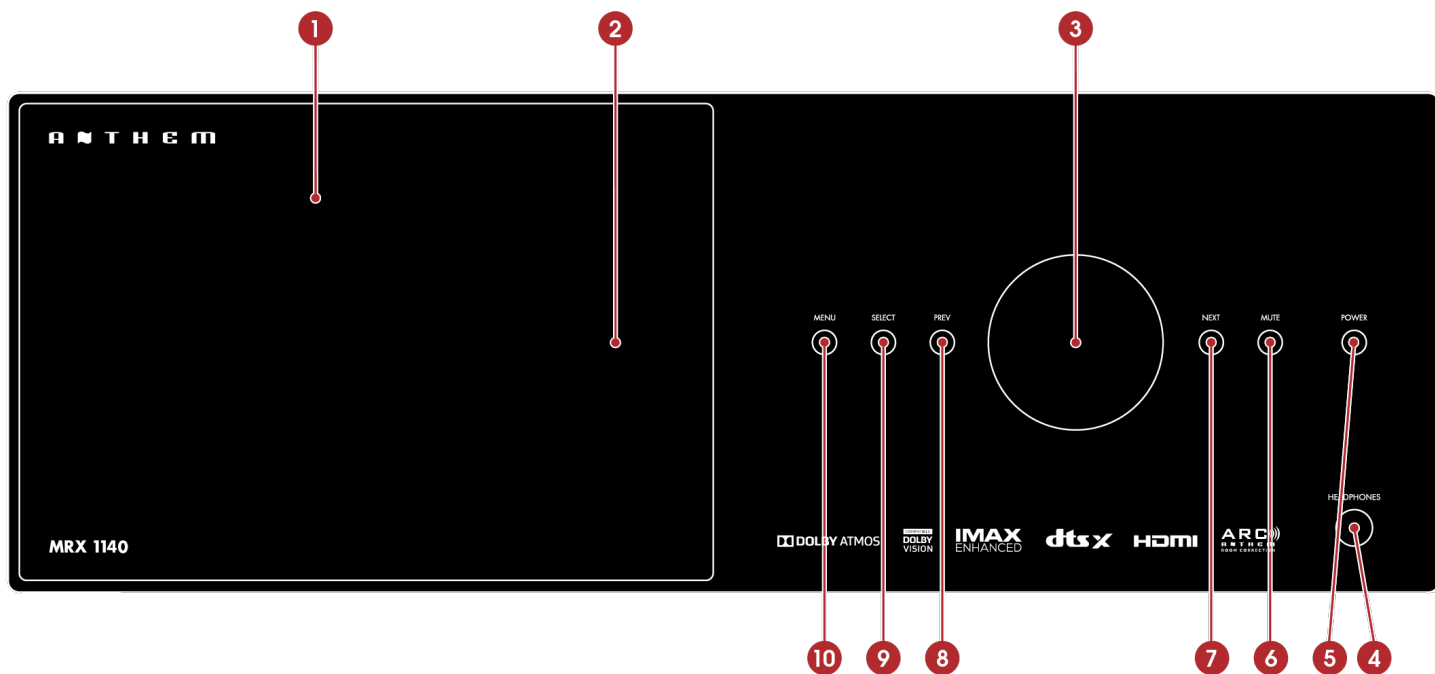

1. Display
2. Remote control sensor location
3. Volume control and menu navigation
4. Headphone jack
5. Power / standby
6. Mute
7. Next input or item
8. Previous input or item
9. Selection confirmation
10. Setup menu access

## 2.4 MRX 1140 REAR PANEL

US model shown. EU model is similar.

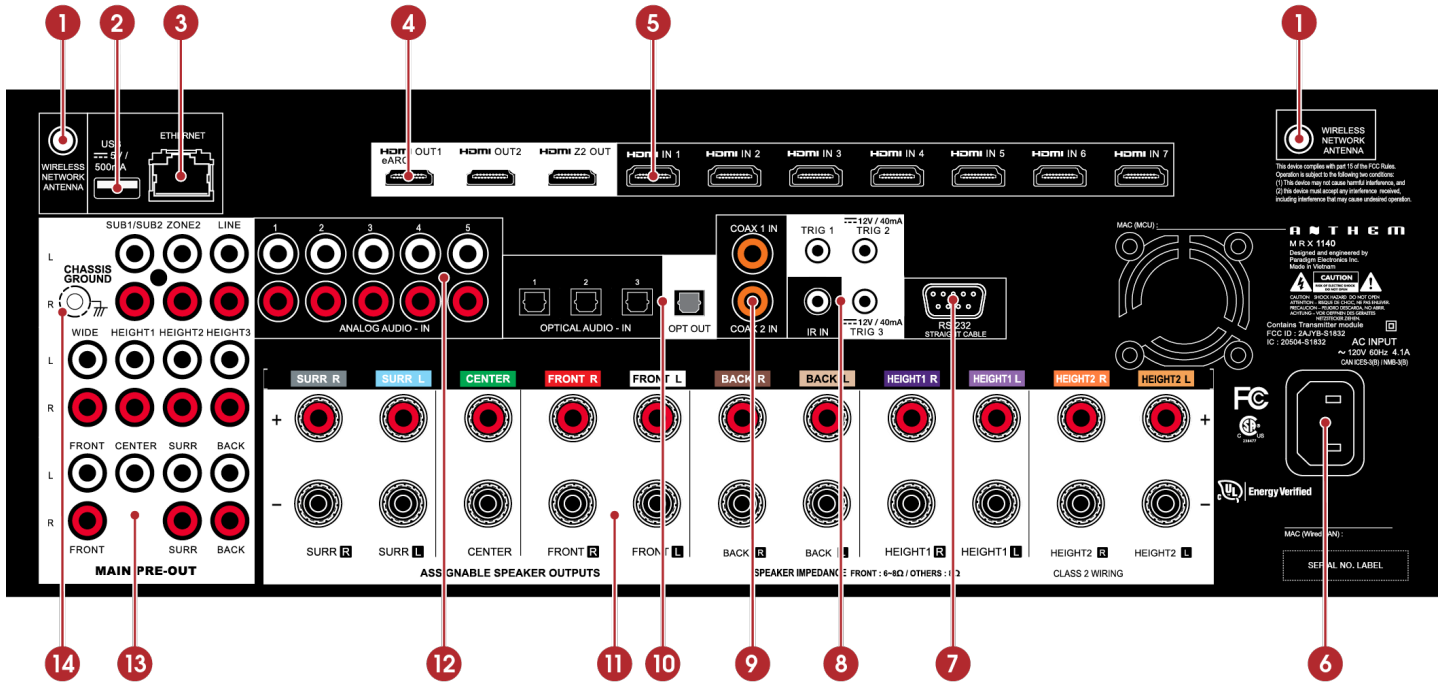

1. Wireless antenna connectors
2. USB jack for factory service
3. Local area network connection for IP control and Anthem Room Correction
4. HDMI outputs: HDMI 1 supports eARC (Enhanced Audio Return Channel)
5. HDMI inputs
6. AC input
7. RS-232 interface (bidirectional) for serial control
8. IR input and trigger outputs
9. Coaxial digital audio inputs
10. Optical digital audio inputs and output
11. Speaker connections
12. Analog audio inputs
13. Pre-out connections
14. Chassis ground screw

## 2.5 MRX 740 REAR PANEL

US model shown. EU model is similar.

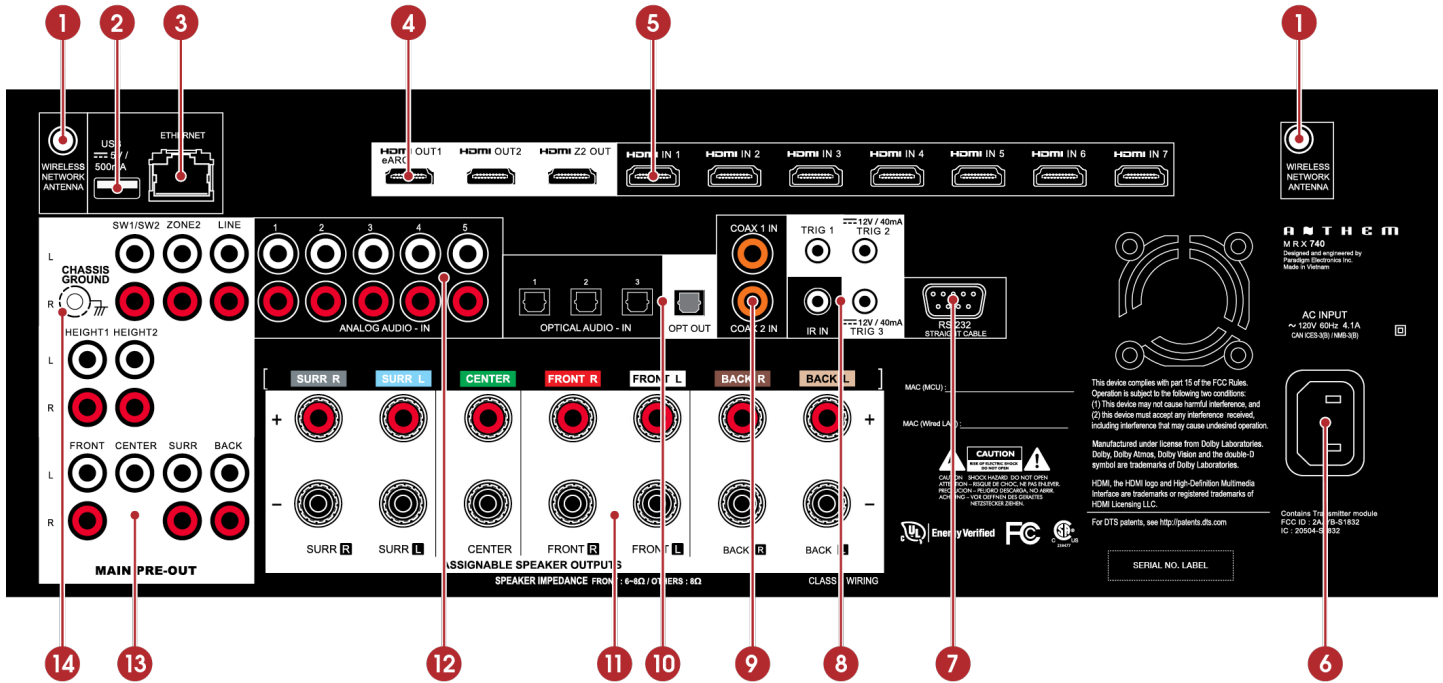

1. Wireless antenna connectors
2. USB jack for factory service
3. Local area network connection for IP control and Anthem Room Correction
4. HDMI outputs: HDMI 1 supports eARC (Enhanced Audio Return Channel)
5. HDMI inputs
6. AC input
7. RS-232 interface (bidirectional) for serial control
8. IR input and trigger outputs
9. Coaxial digital audio inputs
10. Optical digital audio inputs and output
11. Speaker connections
12. Analog audio inputs
13. Pre-out connections
14. Chassis ground screw

## 2.6 MRX 540 REAR PANEL

US model shown. EU model is similar.

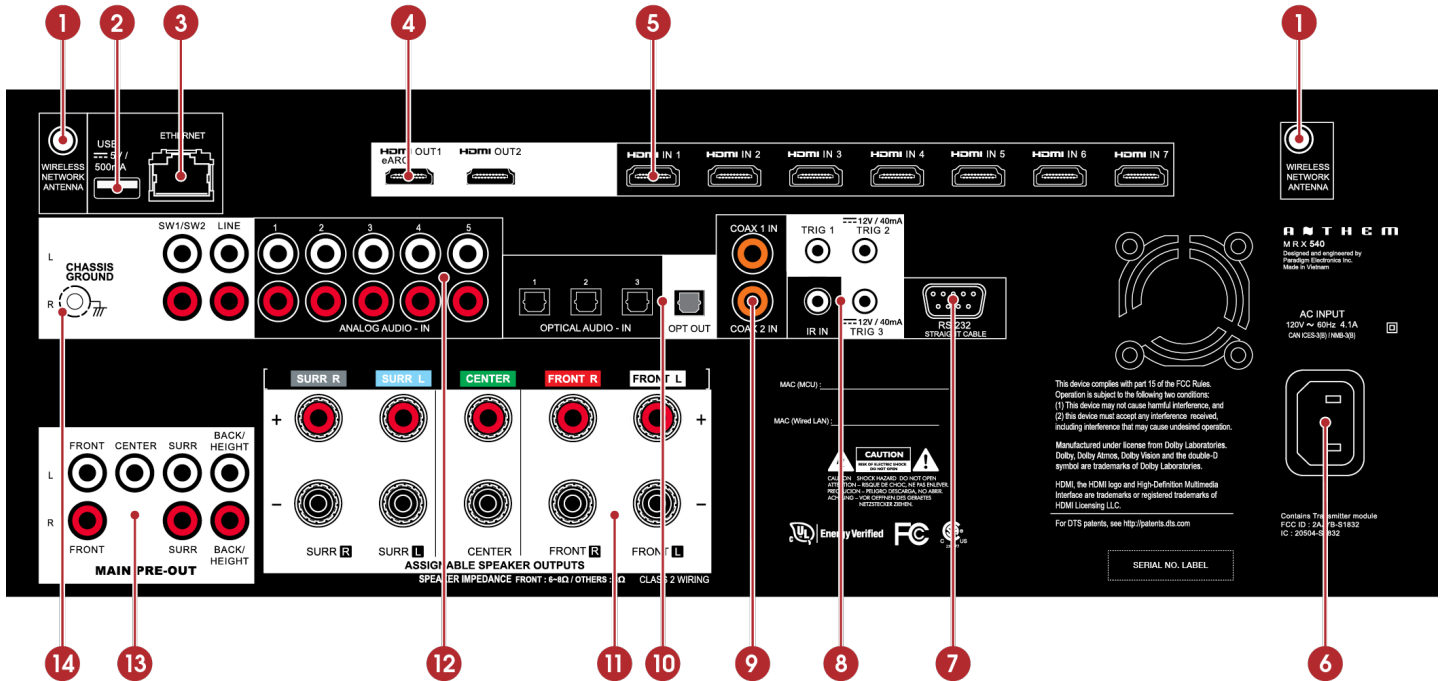

1. Wireless antenna connectors
2. USB jack for factory service
3. Local area network connection for IP control and Anthem Room Correction
4. HDMI outputs: HDMI 1 supports eARC (Enhanced Audio Return Channel)
5. HDMI inputs
6. AC input
7. RS-232 interface (bidirectional) for serial control
8. IR input and trigger outputs
9. Coaxial digital audio inputs
10. Optical digital audio inputs and output
11. Speaker connections
12. Analog audio inputs
13. Pre-out connections
14. Chassis ground screw

## 2.7 AVM 90 REAR PANEL

US model shown. EU model is similar.

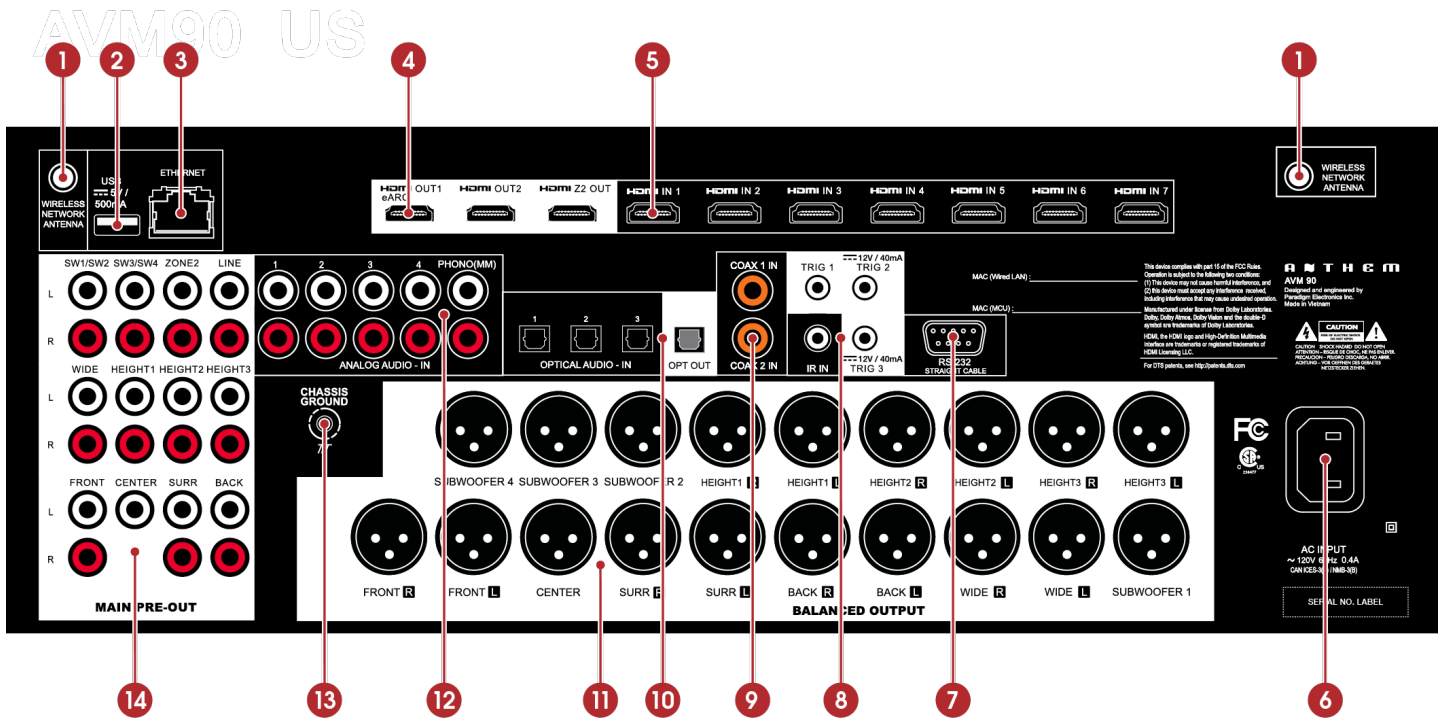

1. Wireless antenna connectors
2. USB jack for factory service
3. Local area network connection for IP control and Anthem Room Correction
4. HDMI outputs: HDMI 1 supports eARC (Enhanced Audio Return Channel)
5. HDMI inputs
6. AC input
7. RS-232 interface (bidirectional) for serial control
8. IR input and trigger outputs
9. Coaxial digital audio inputs
10. Optical digital audio inputs and output
11. Pre-out connections (XLR)
12. Analog audio inputs
13. Chassis ground screw
14. Pre-out connections (RCA)

## 2.8 AVM 70 REAR PANEL

US model shown. EU model is similar.

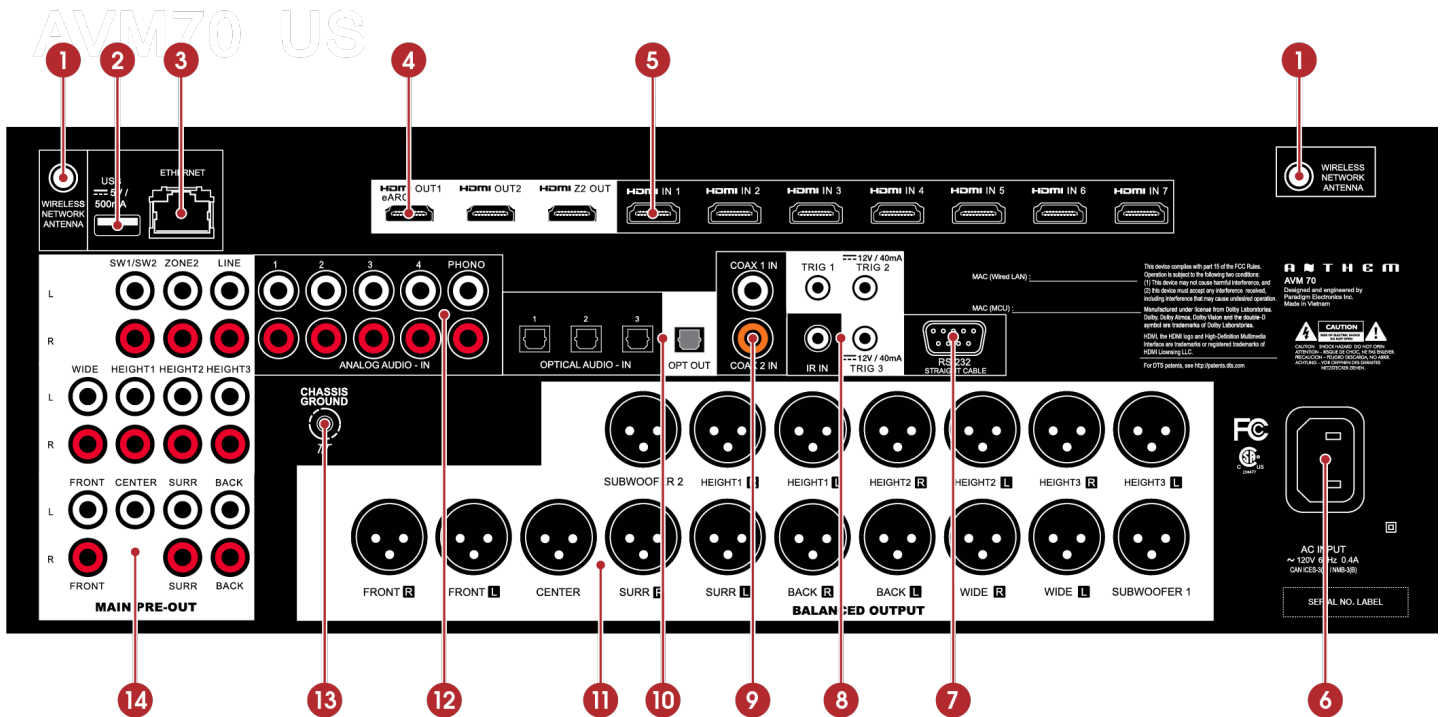

1. Wireless antenna connectors
2. USB jack for factory service
3. Local area network connection for IP control and Anthem Room Correction
4. HDMI outputs: HDMI 1 supports eARC (Enhanced Audio Return Channel)
5. HDMI inputs
6. AC input
7. RS-232 interface (bidirectional) for serial control
8. IR input and trigger outputs
9. Coaxial digital audio inputs
10. Optical digital audio inputs and output
11. Pre-out connections (XLR)
12. Analog audio inputs
13. Chassis ground screw
14. Pre-out connections (RCA)

## 2.9 REMOTE CONTROL

1. Main zone power on
2. Standby
3. Bass
4. Treble
5. Numeric keypad
6. Preset
7. Setup menu
8. Navigation controls
9. Clear for deleting input configurations and clearing new entry
10. Dolby Volume and Dolby Digital Dynamics
11. Volume
12. Zone 2 Controls
13. Backlight
14. PG/PR (DTS:X Dialog Level Control)
15. Lip-sync
16. Mute
17. Surround mode toggle
18. Last
19. Info display (front panel)
20. Input Select
21. Level
22. Balance L/R
23. Dim

The left/right buttons also select previous/next input. The up/down buttons also control tuner station.

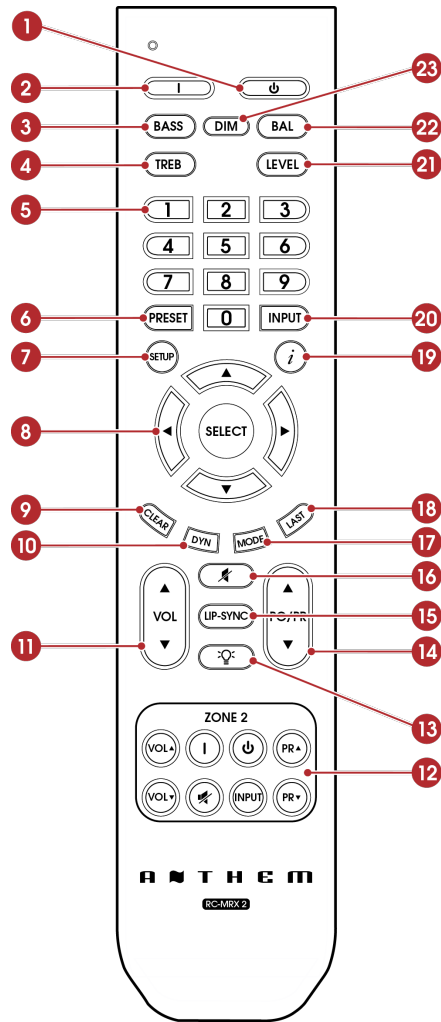

### Packing List:

Install batteries in the MRX/AVM remote control in the directions shown in the illustration below.

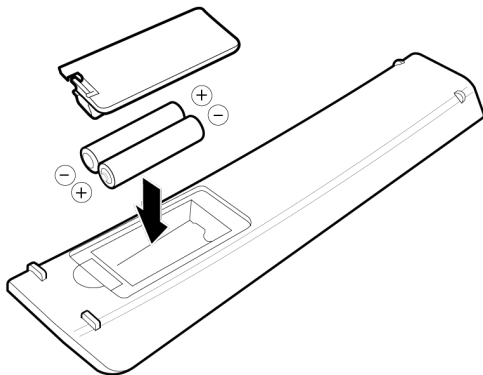



### Remote Control Range of Operation:

The MRX/AVM remote control operates best when used within the range and distance shown in the illustration below.

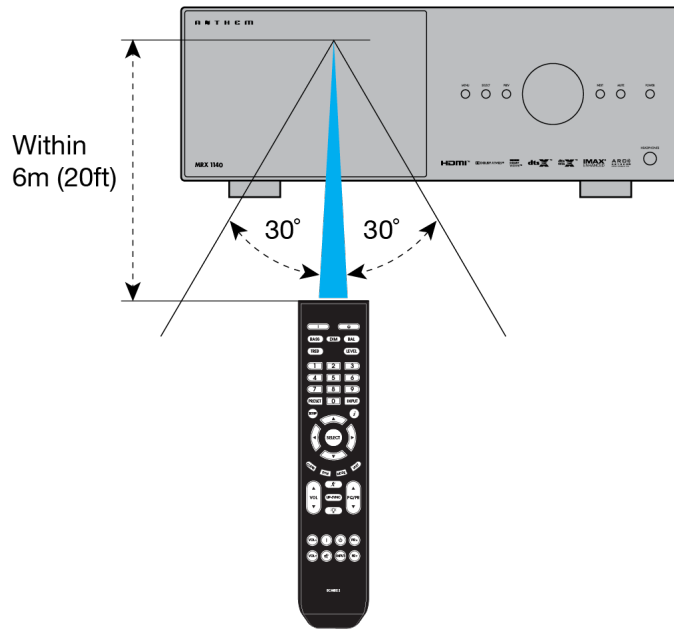

### Rear and Front IR Inputs:

If your remote control is not working and you have already checked the batteries, before contacting technical support, check that Front IR is set to "On" in the Network / Control menu.

# 3.0 SPEAKER POSITIONING

## 3.1 SPEAKERS

Your MRX/AVM, depending on the model, allows connection of anywhere from 2-channels (front left and right speakers with no subwoofer) to 9.4.6-channels (a nine-speaker surround sound system with four subwoofers and six height speakers). When setting up your speakers, care should be taken to achieve the best possible immersive audio experience.

### **Front Left & Right**

The front speakers are what you hear when listening to 2 channel recordings but also play a large part in your home theater setup along with the centre channel playing the majority of content. If using listening to music without a subwoofer it is advised to use full range front speakers.

### **Center**

The center channel is the most important speaker in a home theater system, as the center channel reproduces almost all of the dialogue and a large portion of the front speaker information. The center channel speaker must be accurate, recommended for use as a center speaker, and mate well with the front speakers. The center channel is not the place to cut corners.

### **Surround Left & Right / Back Left & Right**

Surround and back speakers reproduce the information that makes sounds wrap around your home theater space.

### **Subwoofer(s)**

With any surround sound system, you will need one or more high-quality subwoofers (the .1 in 5.1- or 7.1.4-channel surround systems). Most movie soundtracks contain large amounts of bass information as part of the LFE (Low Frequency Effect) track that sends information directly to your subwoofer. Good subwoofers will provide a foundation for the rest of the system and add “weight” to music.

### **Height 1 and Height 2**

Up to six height speakers (the .2 and .4 in 5.1.2- and 7.1.4-channel surround systems) can be connected to allow 3-dimensional Dolby Atmos and DTS:X surround sound. Height speakers reproduce the information that makes it sound as if planes are flying over your head and other similar effects.

### 3.2 5.1-CHANNEL SPEAKER POSITIONING

These illustrations show recommended speaker placements for a 5.1 channel system.

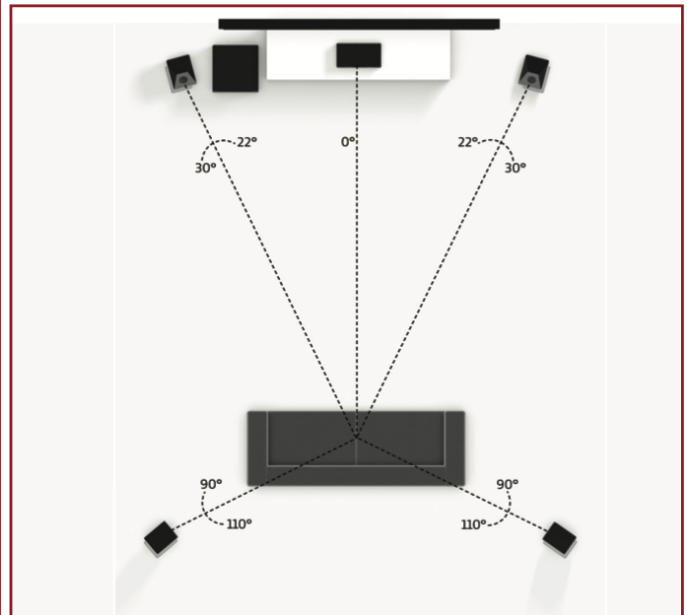
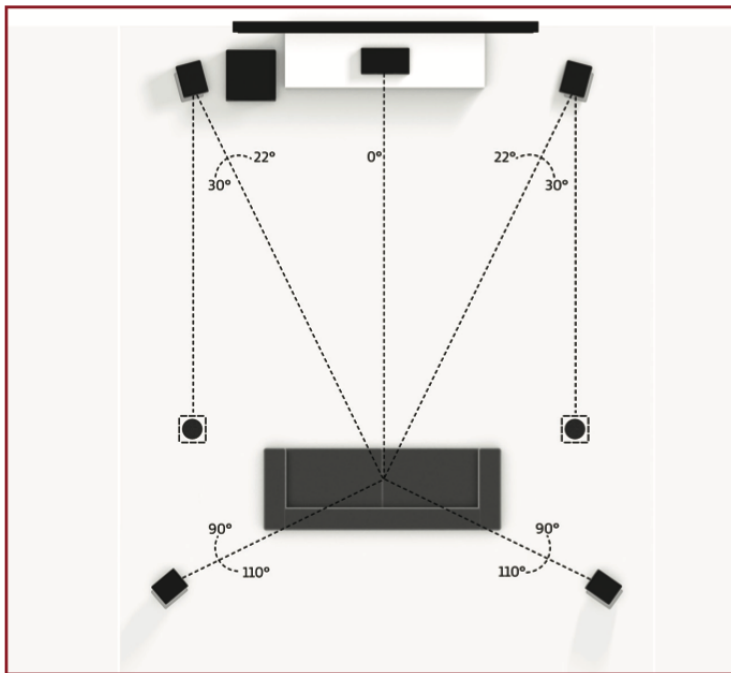

#### 5.1.2 Configuration

with one pair in-ceiling height speakers

#### 5.1.2 Configuration

with Dolby enabled front speakers

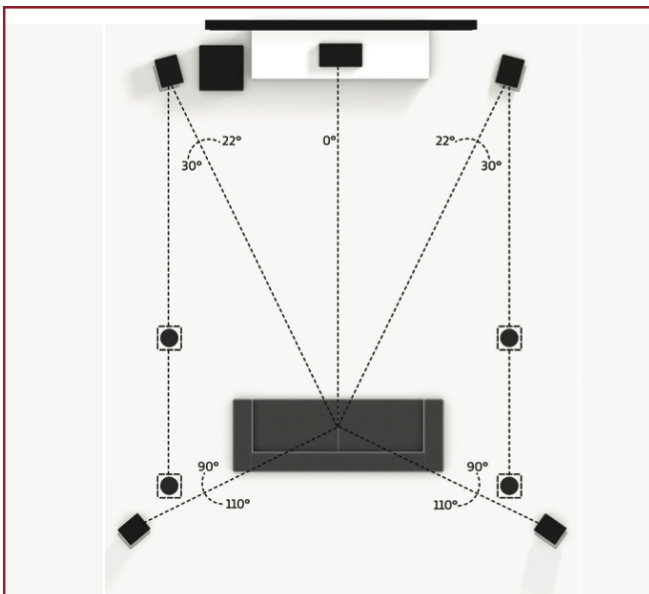

#### 5.1.4 Configuration

with two pair in-ceiling height speakers

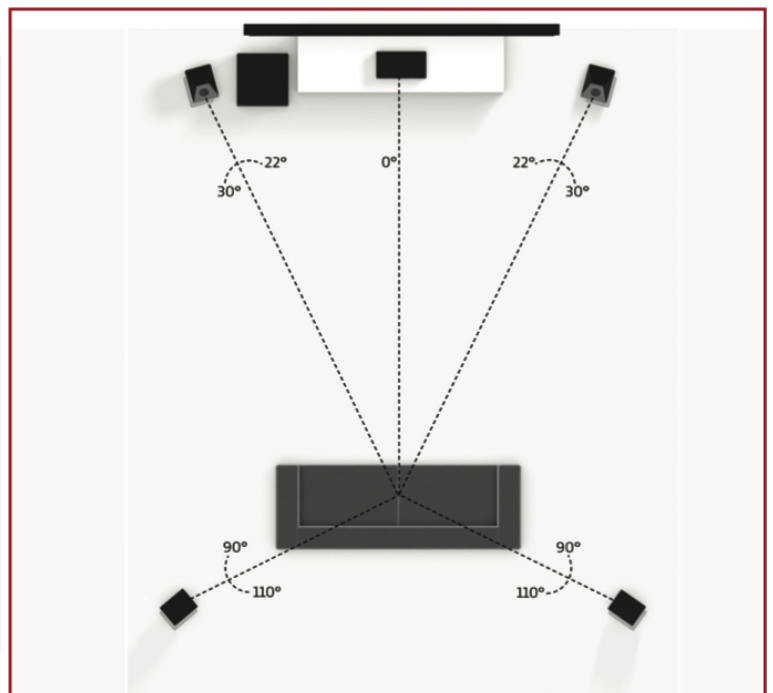

#### 5.1.4 Configuration

with Dolby enabled front and surround speakers

### 3.3 7.1-CHANNEL SPEAKER POSITIONING

These illustrations show recommended speaker placements for a 7.1 channel system. (not all setups are available on the 540 due to number of channels available.)

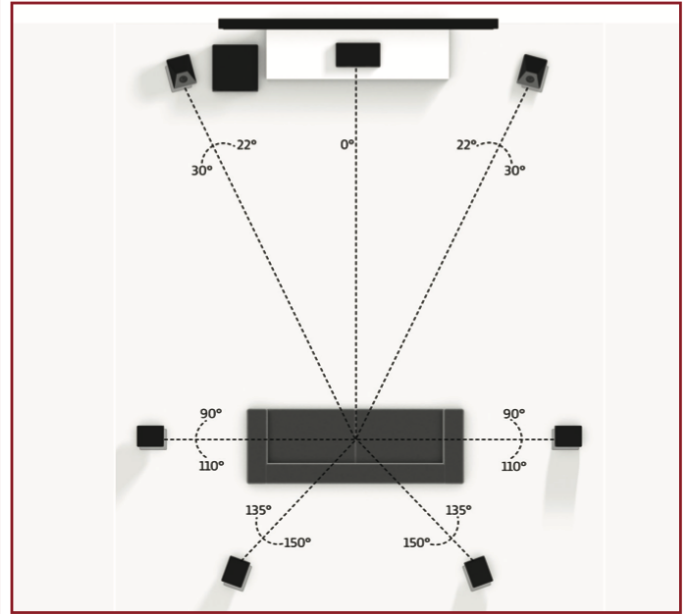
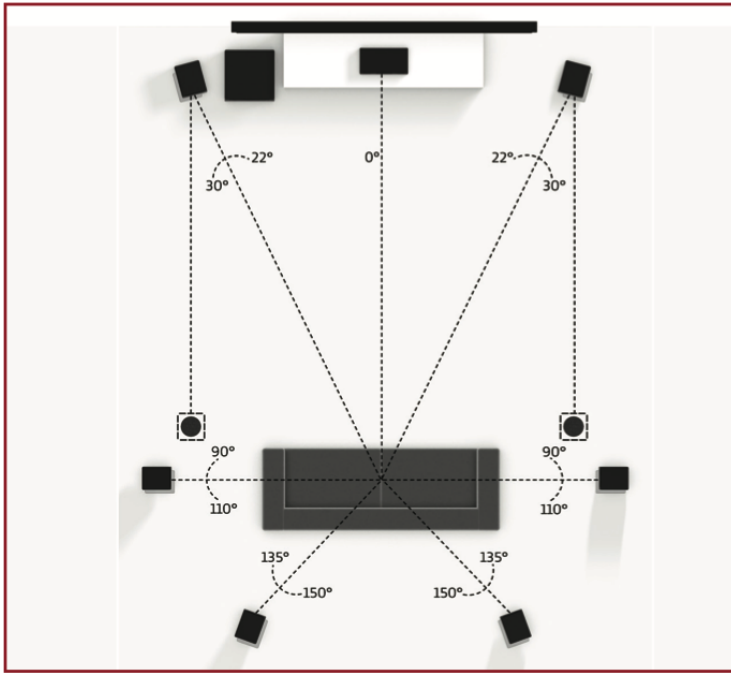

#### 7.1.2 Configuration

with one pair in-ceiling height speakers

#### 7.1.2 Configuration

with Dolby enabled front speakers

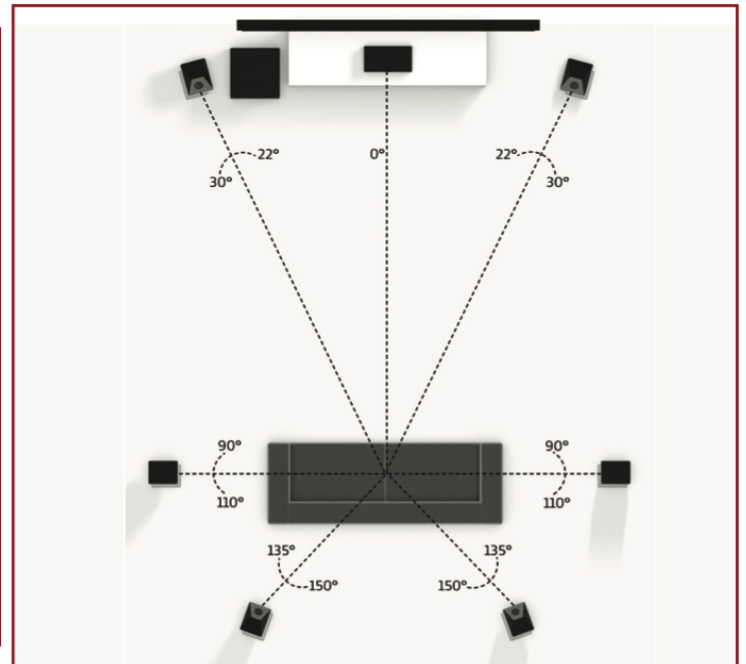
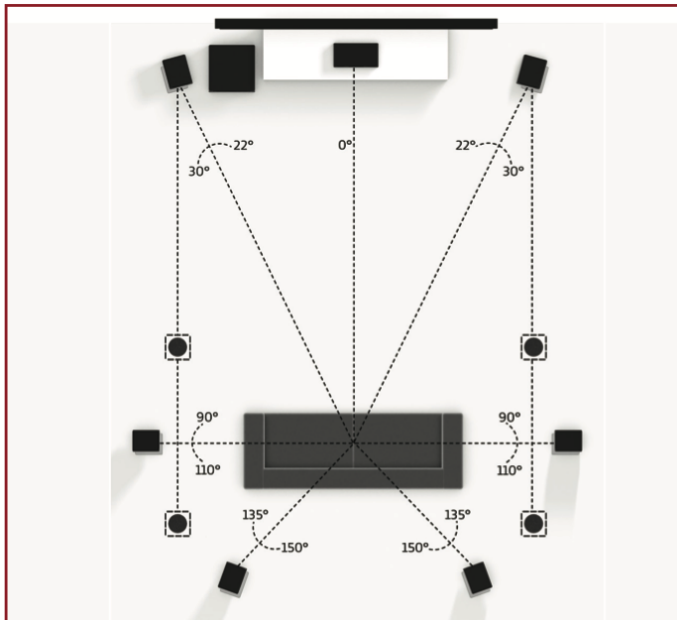

#### 7.1.4 Configuration

with two pair in-ceiling height speakers

#### 7.1.4 Configuration

with Dolby enabled front and rear speakers

### 3.4 HEIGHT EFFECTS SPEAKER POSITIONING

These illustrations show recommended speaker placements when using height effects channels.

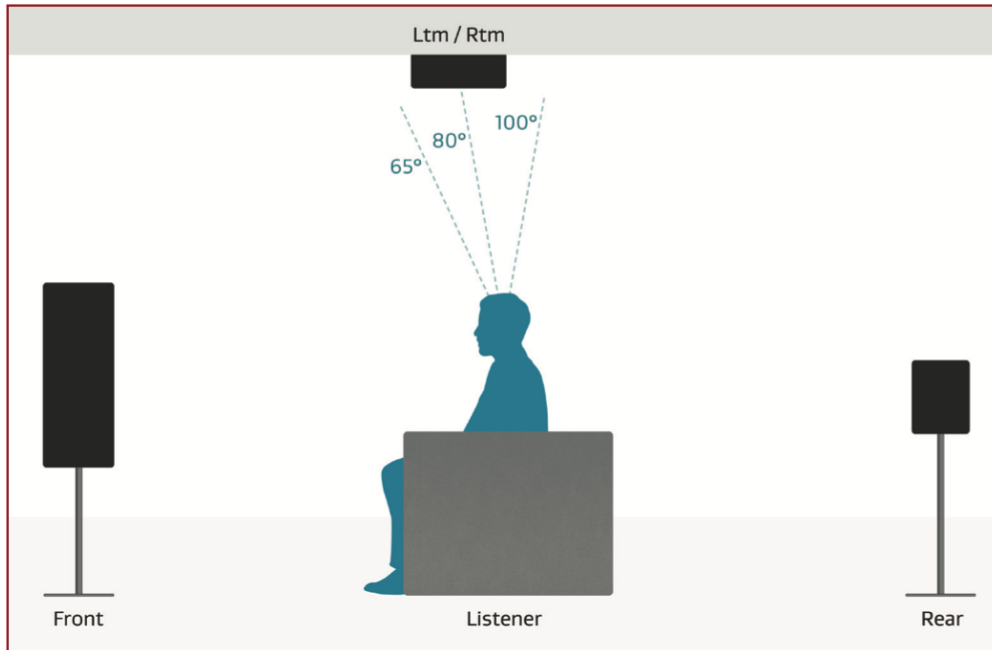

One pair in-ceiling height speakers (side view)

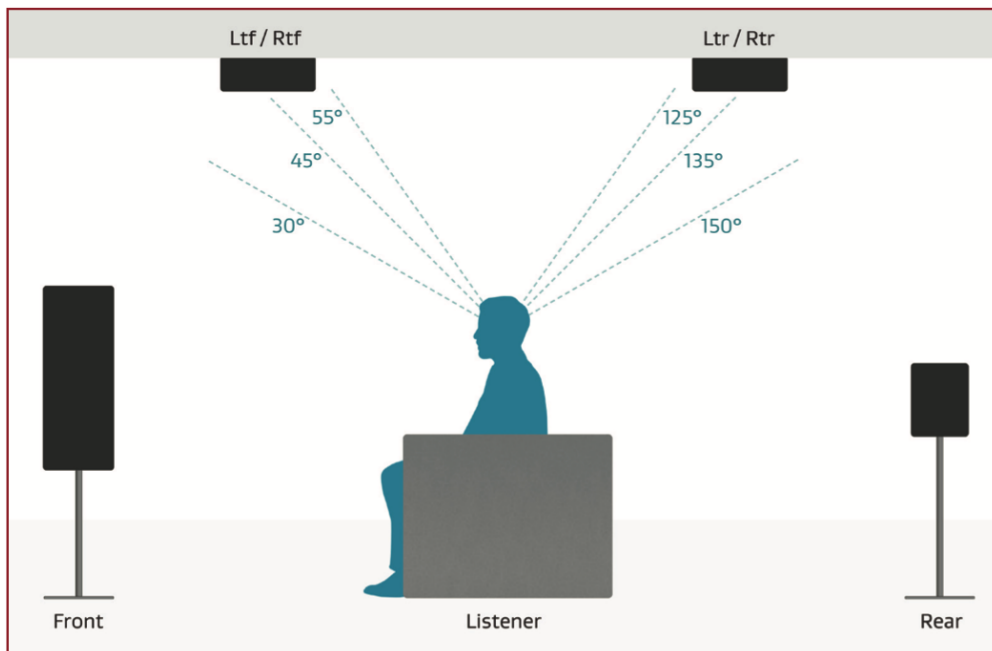

Two pair in-ceiling height speakers (side view)

# 4.0 CONNECTIONS

## 4.1 HDMI VIDEO INPUTS AND OUTPUTS

An HDMI connection carries video and audio together. Connect HDMI output from MRX to a display with HDMI input – one with the appropriate version of High-bandwidth Digital Content Protection (HDCP) is required to display copy-protected material.

Insert HDMI cables gently because the connector is more delicate than traditional ones. Damaged cables can damage jacks, and the warranty does not cover jack replacement. Therefore, replacing HDMI cables is recommended if there is any chance of damage with the existing cable.

Use only certified High-Speed cables and connecting devices. Cables and connecting devices that worked in an older setup do not necessarily work with newer video formats such as Deep Color, UHD, or high frame rates. If you are using adapters or port savers, start troubleshooting by eliminating them since they can affect bandwidth.

## 4.2 AUDIO CONNECTIONS

### HDMI Audio Inputs and Outputs

Digital audio sources can be connected using an HDMI, coaxial, or optical cable. These connections carry linear PCM, and bitstream (Dolby Digital, and DTS audio formats).

An HDMI connection is generally preferred to ensure the use of lossless audio when sources provide it, although you can also use optical/coax connections for sources outputting 2-channel PCM, Dolby Digital 5.1, and DTS 5.1 without affecting audio quality. HDMI outputs restrict audio to 2-channel PCM since these outputs are intended to connect to a television.

### HDMI Enhanced Audio Return Channel

If your television provides audio through HDMI eARC (Enhanced Audio Return Channel), for example, when it accesses streaming media sources, it can send the audio to the MRX/AVM's HDMI output 1 (eARC), eliminating the need for a separate audio connection from the television.

If the display reads “Dial Norm Offset -4.0 dB” at the start of a movie, it is indicating that the encoded level is higher than standard by 4.0 dB. The playback level of all channels is then automatically reduced by 4 dB.

### Optical and Coaxial Digital Audio

If HDMI audio from a Dolby Digital, DTS, or 2-channel PCM source is problematic or takes too long to switch, we recommend the use of an optical/coaxial audio connection (you can still use HDMI for video). Older cable and satellite devices often benefit from this.

The optical output provides a pass-through of the in-use optical/coaxial input.

Optical and Coaxial Audio

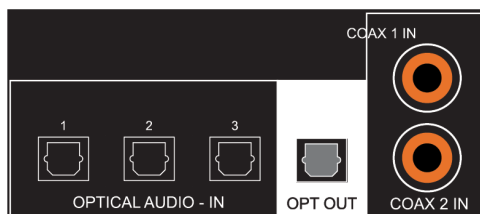

All Models

## Pre-Amp Outputs

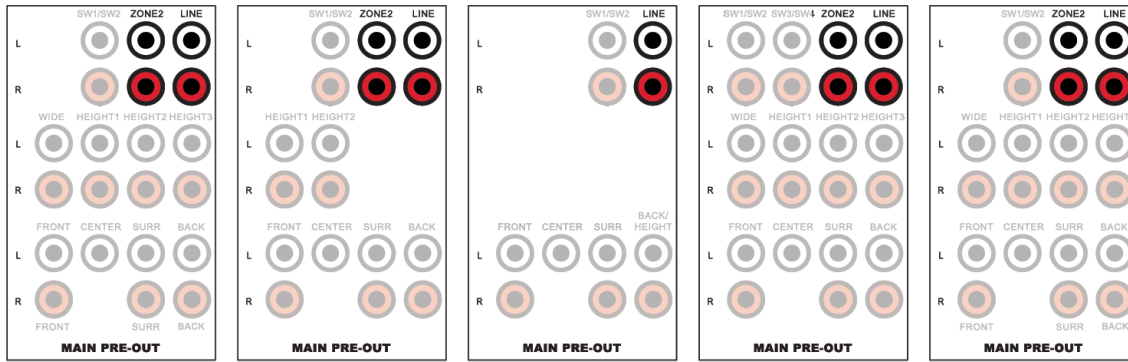

MRX 1140

MRX 740

MRX 540

AVM 90

AVM 70

## Balanced XLR Pre-Amp Outputs (AVM Only)

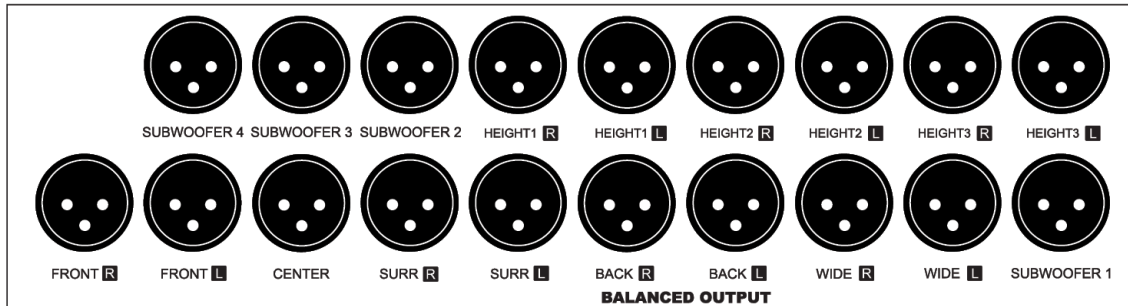

AVM 90

## RCA Pre-Amp Outputs—Using External Amplifiers

The pre-amp outputs, which are variable according to the main zone volume control, are used to connect external amplification. The addition of external amplifiers allows you to supplement or replace internal amplification. This set of connections includes subwoofer outputs.

With MRX 740, external amplification is necessary to add additional back and height effects channels.

With MRX 540, external amplification is necessary to add back and height effects channels.

## Balanced XLR Pre-Amp Outputs (AVM Only) —Using External Amplifiers

Balanced XLR connection offers the highest analog transmission quality, particularly over long cable lengths because it rejects noise and hum pickup. These outputs are provided using the conventional pin-2 positive configuration.

With the AVM models, the RCA and XLR outputs have identical signals at the same time (XLR connections are suitable for longer cables).

## RCA and Balanced XLR Pre-Amp Outputs—Connecting Subwoofers

The pre-amplifier outputs include subwoofer outputs. Although subwoofers are considered to be speaker channels, they are generally self-amplified and, thus, connect in the same way you'd connect an external amplifier. Your AVM/MRX features two subwoofer outputs (the AVM 90 features four). Each sub output has its own position delay, level, and Anthem Room Correction filter, however they all receive the same signal which is the LFE + low-pass portions of small speakers on other channels (MRX540 and 740 have paralleled subwoofer outputs). There is also a mode where front left and right channels are set to large (full range) and the low-pass of left and right channels is also added to the subwoofer.

## Line Output and Zone 2 Output

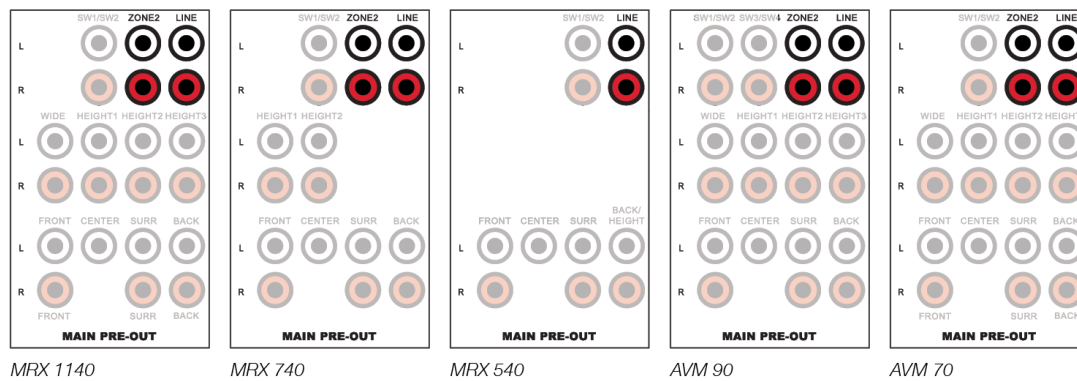

## Analog Inputs

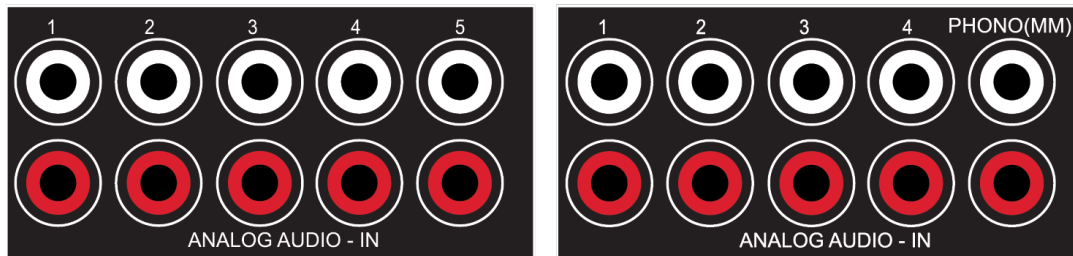

## Line Output and Zone 2 Output

The line output is a 2-channel version of the selected input with a fixed output level. Use this output with a headphone amp or similar device with built-in volume control.

The Zone 2 (all models except 540) output, which has an independent volume control, is used in two ways:

- For independent source selection, connect the source using an analog input, optical/ coaxial input or HDMI.
- Note, for AVM 70/90, external amplification is always necessary when adding Zone 2 speakers.
- Note, for MRX 740 and MRX 1140, if you are using all available sets of binding posts for the main zone's speaker system, external amplification is necessary for Zone 2. Otherwise, some unused channels can be assigned to power Zone 2 which can be found in the Speaker Setup > Amp Matrixing menu and will be explained further in the Speaker Setup section.

## Analog Inputs

There are five RCA line inputs. On AVM models, the fifth analog input is a dedicated phono input suitable for a turntable with a moving-magnet (MM) phono cartridge. When using a turntable, connect the ground wire from the turntable to the screw terminal next to the phono inputs to prevent excessive hum. Note, if you are using a turntable with a moving-coil (MC) phono cartridge, you will need a separate phono preamp which will connect to the standard analog inputs because there will not be enough gain on the (MM) input.





## Speaker Connections (MFX Only)

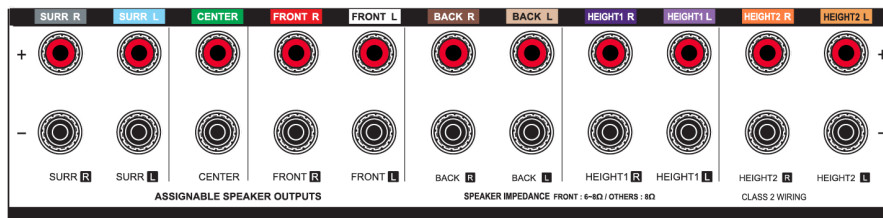

MFX 1140

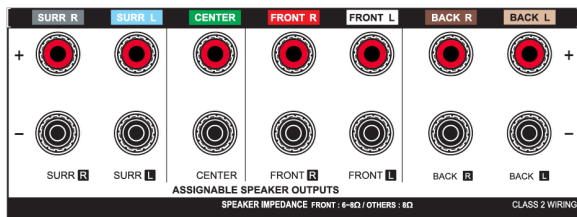

MFX 740

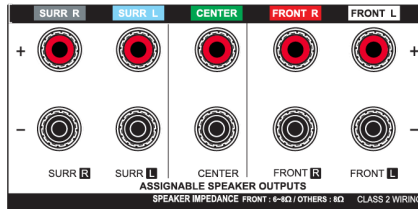

MFX 540

## Speaker Connections (MRX Only)

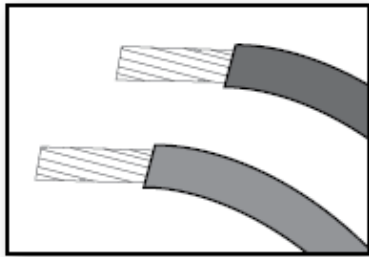

Using speaker wire, connect the positive (+) connection on the speaker to the positive (+) binding post on the appropriate amplifier output, and the negative (-) on the speaker to the negative (-) binding post on the same amplifier channel using cable that is insulated to handle the maximum output of the amplifier.

When preparing speaker wire, carefully remove insulation using a wire stripper and tightly twist the loose end of the wire. Make sure no loose strands from frayed speaker cables contact another cable or the MRX's case.

To insert the speaker wire, loosen each binding post by twisting it counterclockwise and insert a wire into the hole that opens. Close the binding post by turning it clockwise. Do not over-tighten. Check the connection by gently tugging on the connected cable.

US models allow banana connectors. If using them, before inserting the banana connector, turn the binding post clockwise until it is closed (this allows full insertion of the banana connector). If a banana plug is connected to an output that is not fully tightened, it will likely fall out.

Do not connect more than one speaker to each amplifier output. Be sure to turn off the power when connecting or disconnecting anything. Only use speakers rated for use with this MRX/AVM.

### 4.3 LOCAL AREA NETWORK

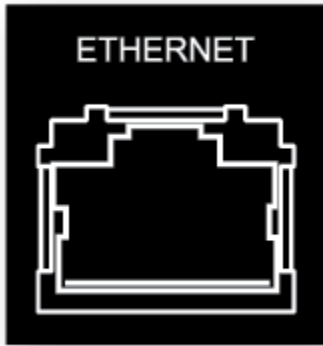

Configuring Anthem Room Correction, streaming or using IP control requires a network connection. To use a wired connection, connect your router using CAT cable.



If using a wireless connection, add the two network antennas to the rear panel. The setup section of this manual explains how to set up a wireless connection. Please note, if mounting the MRX/AVM in a metal rack, we recommend a wired network connection, especially if the wireless router is in a different room or if anything else can impact the signal strength.

Wireless antennas are also required for Bluetooth connection.

If using a firewall for security, ensure that the MRX/AVM is permitted to join the network.

#### 4.4 12 VOLT TRIGGER

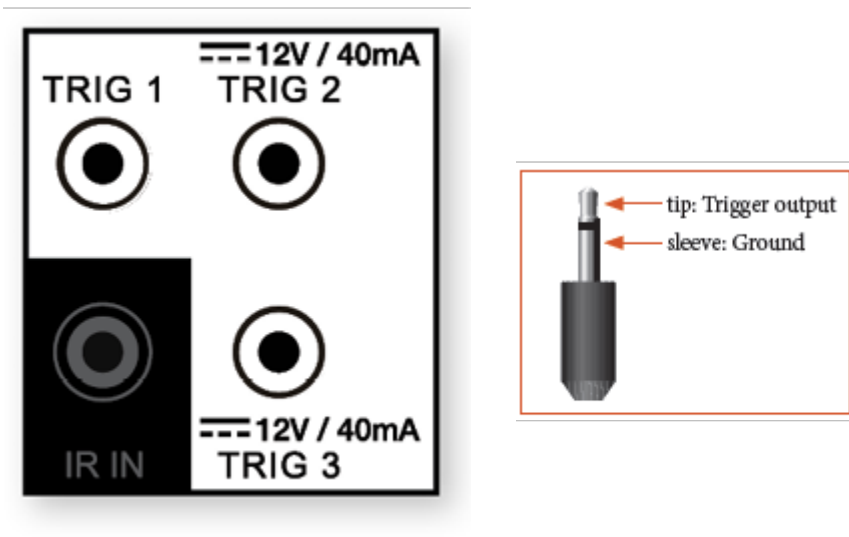

If another system component has a trigger input, the MRX/AVM can activate it (as long as it requires 40mA or less). Connect the MRX/AVM's trigger output using a cable with 3.5mm mini-plugs. The MRX/AVM provides flexible trigger options. Through the setup menu, you can specify the conditions for enabling triggers.

#### 4.5 INFRARED

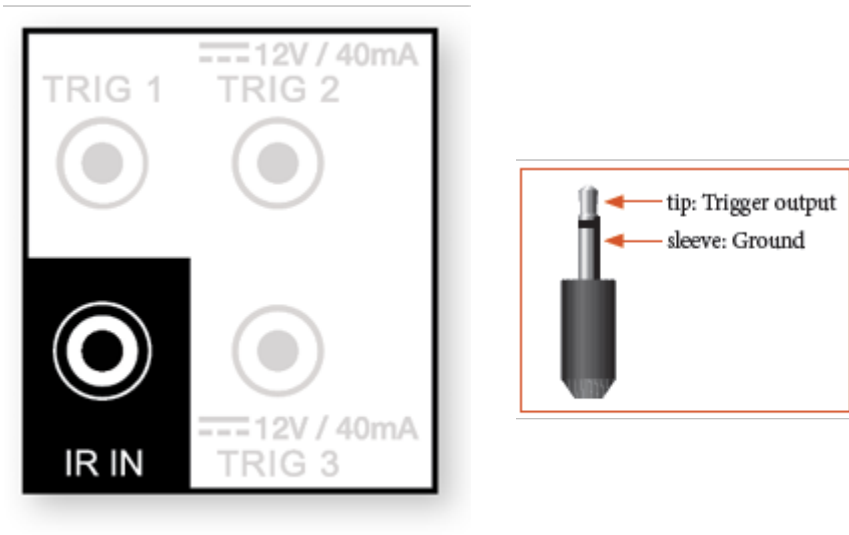

An external IR receiver allows the use of the remote control from another location in your home - connect the MRX/AVM from an external IR hub to the IR IN jack. Most powered IR repeater kits are compatible, but to avoid problems, test compatibility before installing permanently.

## 4.6 RS-232



The RS-232 connection allows connection to a compatible control system. The control system should be configured to use 115200/8-N-1, no flow control, protocol. The cable connection should be one to one.

## 4.7 POWER

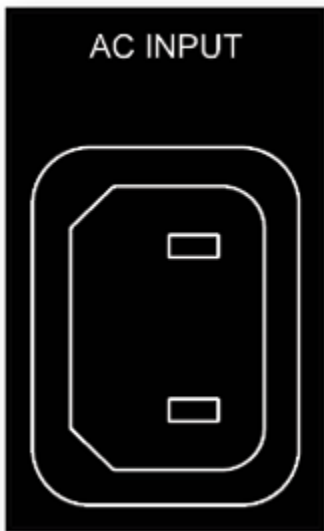

Insert a power cord into the MRX/AVM's AC input. Plug the cord into a wall outlet. Ensure that the AC supply matches the voltage rating shown on the back of the MRX/AVM. The 230V models support voltages from 220V to 240V. Route audio and video cables away from the power cord to reduce potential sources of hum and other interference.

## 4.8 HEADPHONE JACK (FRONT PANEL)



This socket accepts headphones with an impedance rating between  $32\Omega$  and  $600\Omega$ , fitted with a 6.35mm stereo jack plug. The headphone socket is always active, except when Receiver is muted. When the headphone jack is inserted, the speaker outputs and analogue preamplifier outputs are muted by default, the preamplifiers can be activated with the headphones jack in within the Preferences menu.

# 5.0 SETUP

## 5.1 SPEAKER SETUP

If a source component, such as a Blu-ray player or media streamer, also offers bass management and time alignment, be sure to disable the source device's built-in bass management and time alignment. Do this by setting all channels to "large" and setting identical values for distance to the listener (your source doesn't need to handle these settings since the MRX/AVM performs these tasks). Performing these processes twice will degrade audio quality.



### Amp Matrixing (740/1140)

This option allows you to assign amplifier channels to different channels of information. This is meant to allow you to replace certain amp channels with external amplification and still be able to use the amplifier channels to power other speakers, for example it is common to use an external amplifier to power the Front Left and Front Right speakers if they require more power, you can use this menu to assign the amplifier channels originally used for these speakers to power other speakers such as Height or Zone 2. The Centre channel cannot be reassigned because it is a single channel while everything else is a pair.

### Bi-Amp

This option allows you to use unused channels to apply extra amplification to your front speakers, this should only be used if your front speakers have the connections that allow bi-amping. Bi-amping is useful for separating the high-frequencies on a speaker from the low-frequencies, this is especially useful if there is any audible distortion in the bass section. Note that bi-amping does not "double" the power to the speaker, it applies the same amount to your speaker in two different areas.

### Zone 2 on Demand

When "Zone 2 on Demand" is ON then Back speakers will be set to Zone 2 when Zone 2 is powered on, when Zone 2 is powered off, the Back speakers will revert to their option chosen in the Amp Matrixing menu. When "Zone 2 on Demand" is OFF, the Back speakers will follow the Amp Matrixing selection always.

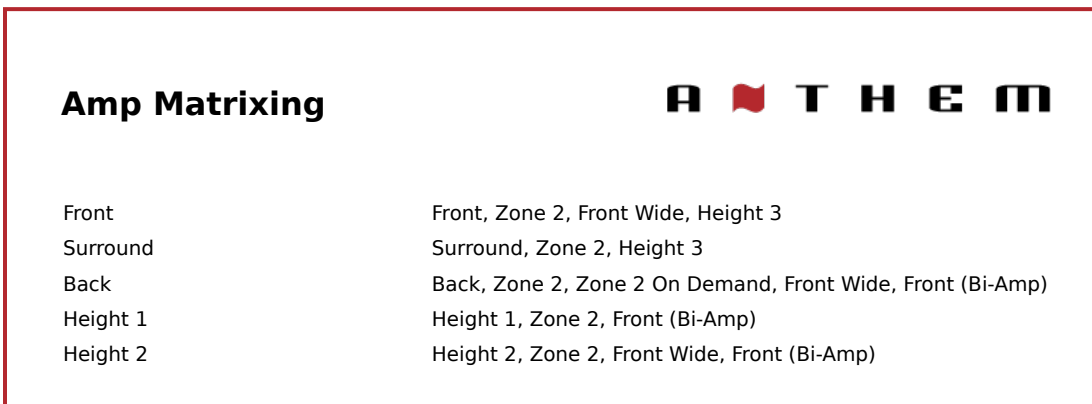

(MRX 1140)

### 3D Sound

MRX 1140, by default, is configured for amplification for 7.1.4 main speakers, MRX 740 for 7.1 main speakers, and MRX 540 for 5.1 main speakers. You can assign height channel information to be sent correctly to the speakers.

### Height Speaker Type and Position

Two, four or six speakers may be installed in the ceiling or on the wall near the ceiling and 1 pair of Front Wide. Or, you may place a type of height speaker referred to as Dolby- enabled on top of existing speakers. A Dolby-enabled speaker works by bouncing height information off the ceiling. Using the room layout diagrams in this manual as a guide, select from the following possibilities to match your height speakers:

- Front In-Ceiling
- Front Dolby-enabled
- Front On-Wall
- Front Wide
- Middle In-Ceiling
- Middle Dolby-enabled
- Back In-Ceiling
- Back Dolby-enabled
- Back On-Wall

<b>3D Sound</b>	<b>A N T H E M</b>
Height 1	Front In-Ceiling
Height 2	Middle In-Ceiling
Height 3	Back In-Ceiling

### Four Speaker Profiles

The use of one speaker profile is suitable for most systems. However, the MRX/AVM allows up to four unique profiles with unique speaker selections, bass management, listening position, level calibration, and Anthem Room Correction (ARC) equalization values. Multiple speaker profiles are useful if your listening room varies according to predictable sound-altering characteristics such as screen up versus down, a door open versus closed, or stereo listening for music vs. home theatre.

Speaker profiles can be set up manually using the MRX/AVM's front display menu or web user interface. However, it is easier to configure profiles using Anthem's ARC Genesis software.

<b>Speaker Setup</b>	<b>A N T H E M</b>
Profile Name	Profile 1
Subwoofer	1
Front	On
Front Wide	On
Center	On
Surround	On
Back	On
Height 1	On
Height 2	On
Height 3	On

## Profile Name

By using the remote control or the front panel navigation keys and volume knob, each profile can be renamed, up to 16 characters long. When finished, press SELECT. However, please note that it is best to set profile names in Anthem Room Correction because, during file upload, ARC overwrites the name set in the menu.

## Subwoofer / Center / Surround / Etcetera

Anthem Room Correction automatically sets these.

For manual setup, if you are using any of these speakers, set each to "On." Otherwise, set them to "Off." This step is essential to keep sounds from going missing. Setting unavailable channels to "Off" causes sound (that would otherwise have come from those speakers) to reroute to the appropriate available speakers. Front speakers cannot be turned off, these are required for all profiles.

## 5.2 BASS MANAGEMENT

Subwoofers play two things, LFE (Low-Frequency Effects) channel sound in multichannel soundtracks and bass redirected from speakers that are configured to use a crossover (i.e., there's a Hz value set in the bass management menu instead of being set to "Off"). Some people prefer to play 2-channel music without the use of a subwoofer. The reason often cited for this is that subwoofers do not blend well with the main speakers. Do not fear! Anthem Room Correction excels in integrating subwoofers with the main speakers. When using Anthem Room Correction, we strongly recommend using at least one subwoofer to enhance all the speakers. A subwoofer, with a built-in amplifier, plays bass that is louder, deeper, and with less distortion than that of most full-range speakers. (there are some amazing full range speakers and not that great subwoofers available so this is a general rule of thumb)

In this menu, enter information about your speakers so that bass does not become distorted. The bass manager is a crossover that divides the audio into two frequency bands. The result is less bass going to speakers, and more bass going to the subwoofer.

If your subwoofer has a built-in crossover, set it to "bypass" or set its frequency control to the highest frequency since the MRX/AVM handles this.

Similarly, if your subwoofer has a phase option, set it to 0 since the MRX/AVM handles this as well. Highlighting Bass Management, then pressing SELECT displays this menu:



Four configurations may be set up. Each contains the following:

<b>Profile # Selection</b>	<b>A N T H E M</b>
LFE Low Pass Filter	120 Hz
Subwoofer 1 Phase Frequency	80 Hz
Subwoofer 1 Phase	0
Subwoofer 1 Polarity	Normal
Subwoofer 2 Phase Frequency	80 Hz
Subwoofer 2 Phase	0
Subwoofer 2 Polarity	Normal
Subwoofer 3 Phase Frequency	80 Hz
Subwoofer 3 Phase	0
Subwoofer 3 Polarity	Normal
Subwoofer 4 Phase Frequency	80 Hz
Subwoofer 4 Phase	0
Subwoofer 4 Polarity	Normal
Front Cross Over	80 Hz
Super Sub Fronts	No
Front Wide Crossover	80 Hz
Center Crossover	80 Hz

### **Subwoofer Phase**

Subwoofer Phase allows you to add electronic delay to the subwoofer signal going to the specified subwoofer. This can be useful to help the subwoofer(s) better integrate with the speakers.

### **Phase Frequency**

Phase Frequency allows you to select at which frequency the phase shift is applied. (generally the same frequency as the crossover)

### **Subwoofer Polarity**

Not to be confused with 180 degrees of phase. Similar to phase, this setting can be used to achieve balance between your speakers and the subwoofer. Inverting the polarity will make your subwoofer's driver operate opposite to your speakers, when your speakers driver's move out, the subwoofer's will move in.

### **Crossover Frequency**

The range is 40 to 200 Hz in 10 Hz steps, or "Off" (which prevents bass for that channel from being diverted to a subwoofer). Setting a channel's crossover to "Off" is not recommended. Note that a crossover does not cut frequencies off like a cliff, but rolls them off according to a slope. If set to 80 Hz, for example, frequencies lower than 80 Hz still play below 80 Hz, but gradually roll-off. Setting the crossover to a number equal to your speaker's specified low-frequency response value is unlikely to provide the best result. This is set automatically when you run Anthem Room Correction.

### **Super Sub Fronts**

Full frequency range stereo is fed to the front left and right channels and bass is sent to the subwoofer. In this case the low frequency information is effectively doubled which may result in unpredictable and colored low frequency reproduction. This setting is not recommended for accurate sonic reproduction.



## 5.3 LISTENER POSITION

These settings achieve proper imaging by coordinating the sound from all speaker channels to reach the listening area at the same time. The channels with the longest distance setting have no delay. The sounds from channels with shorter distance settings have a delay.

Set these values before or after running ARC (ARC does not set distances, and these settings do not affect the room correction process).

### Listener Position



Profile 1 Selection  
Profile 2 Selection  
Profile 3 Selection  
Profile 4 Selection

For measurement units, select “feet” or “metres” within the Preferences menu.

These following settings display for each configuration:

### Profile 1 Selection



Subwoofer 1	12 Feet
Subwoofer 2	12 Feet
Subwoofer 3	12 Feet
Subwoofer 4	12 Feet
Front Left	12 Feet
Front Right	12 Feet
Front Left Wide	12 Feet
Front Right Wide	12 Feet
Center	12 Feet
Surround Left	12 Feet
Surround Right	12 Feet
Back Left	12 Feet
Back Right	12 Feet
Height 1 Left	12 Feet
Height 1 Right	12 Feet
Height 2 Left	12 Feet
Height 2 Right	12 Feet
Height 3 Left	12 Feet
Height 3 Right	12 Feet

Enter the distance between your primary listening area and each speaker. The range is 0-30 ft in 2 in increments or 0-9 m in 5 cm increments.

## 5.4 LEVEL CALIBRATION

Anthem Room Correction automatically sets these items during measurement, and you may skip this menu.

Level Calibration uses internally generated test noises to match speaker output levels at the listening position. These noises are also a way of checking system connections between receiver, amplifier, and speaker. We do not recommend audio calibrations from home theatre setup discs because some use incorrect methods.

If not using ARC, we recommend a sound pressure level (SPL) meter with C-weighting, especially to set the subwoofer level. Measure the sound pressure from the listening position while pointing the meter up and holding it away from your body to prevent reflections. Adjust the level of each speaker until the meter reads 75dB SPL. The volume level setting on the MRX/AVM does not matter when using test tones. Level adjustment is limited to plus 12dB to protect speakers. If your speakers require more than 12dB of adjustment, consider moving your speakers or listening position.



These following settings display for each configuration:

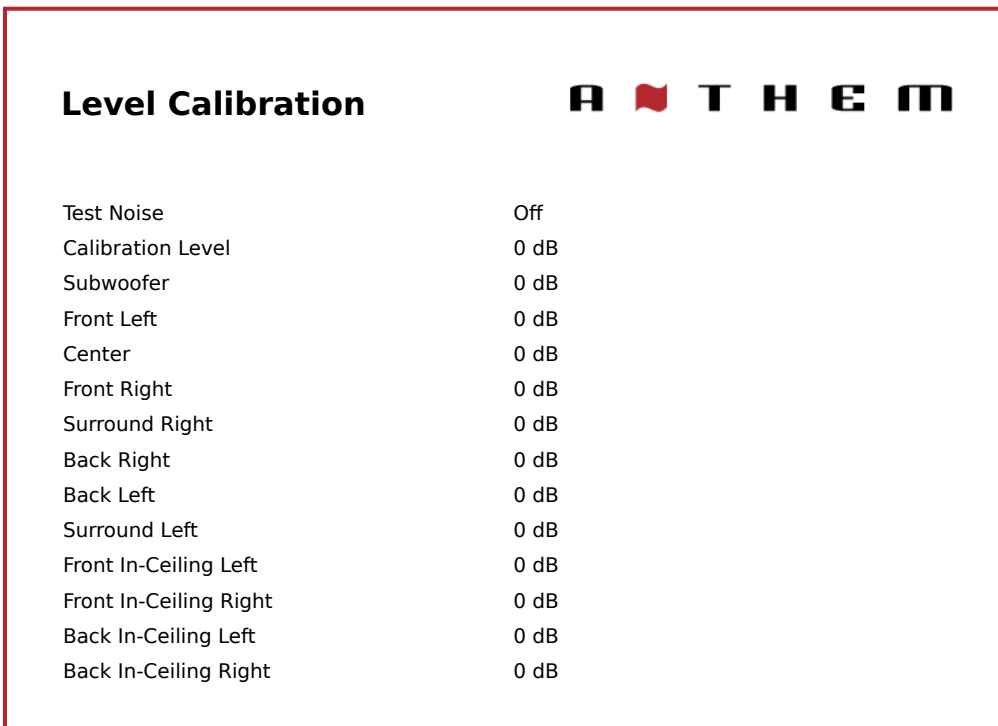

### Test Noise

To play the test noise, select "On." Use the up/down buttons to move the sound to the other speakers.

### Calibration Level

This setting adjusts the master volume for this menu's test noises. It changes the output of all channels, but the sound only comes out of the front left channel when adjusting this setting.

## **Channel Levels (Subwoofer, Front Left, Center, Etcetera)**

If you're calibrating by ear, use the remote control and sit in the listening area. Adjust each channel's loudness until all levels sound the same. If using an SPL meter, adjust the level until it reads 75 dB for each channel. If Front Left was at 0dB when you set Calibration Level, then no adjustment of Front Left is necessary. If using a powered subwoofer, adjust the sub's built-in level control before setting the subwoofer level in this menu or using ARC. Speakers set to "Off" in the Bass Management menu can not be adjusted. Note that if ARC has been used to set levels and is then turned off, the subwoofer level should be reduced by the same amount as room gain, or else you'll hear elevated subwoofer output.

## **Multiple Subwoofers**

If using multiple subwoofers, you should balance them with one another before calibrating the rest of your system. If using ARC, use the Quick Measure function to help find a flat response as a preliminary step before running full measurement. If setting up the traditional way, play the subwoofer test noise with only one subwoofer connected at a time. If using two subs, set the subwoofer's built-in input level so that the SPL meter reads 71 dB from the listening area. Target 67 dB if using four subs. Repeat this for the remaining subs, balancing each to the target level. With all subs connected at the same time, the result should be around 75 dB. Make the final adjustment in the level calibration menu.

## 5.5 INPUT SETUP

In this menu, you configure inputs and listening mode presets. The unit comes programmed from the factory with thirteen inputs (fourteen on AVM), but you may change this to create up to 30 inputs. MRX/AVM uses virtual inputs that give you complete control of the name of each input you create, along with which video (HDMI) input to use, which audio input (HDMI, digital, analog, bluetooth or streaming) to use, which speaker profile to use, and much more. You can even create multiple inputs for the same source device. For example, a Blu-ray input configured for 7.1.4-channels and another Blu-ray input using the same player configured for 2-channels (and no subwoofer).

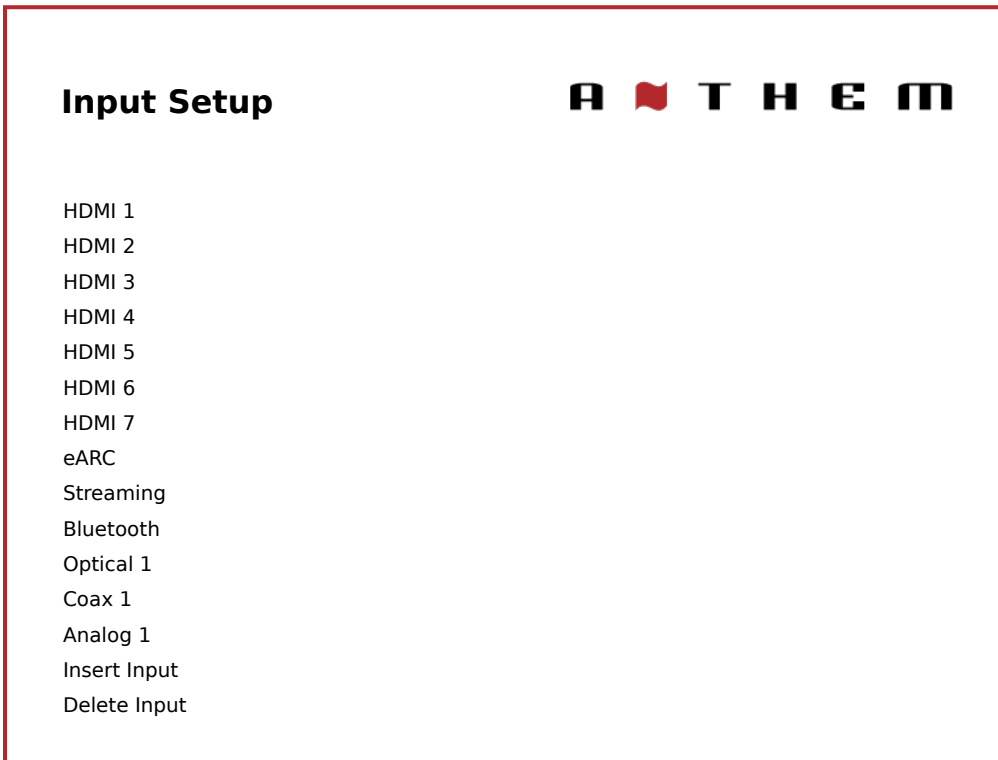

To add a new input at the end of the list, highlight “Insert Input” and press SELECT.

To delete an input, highlight “Delete Input”, press “SELECT”, highlight the input you want to delete and press “SELECT” again.

The following settings display for each configuration:

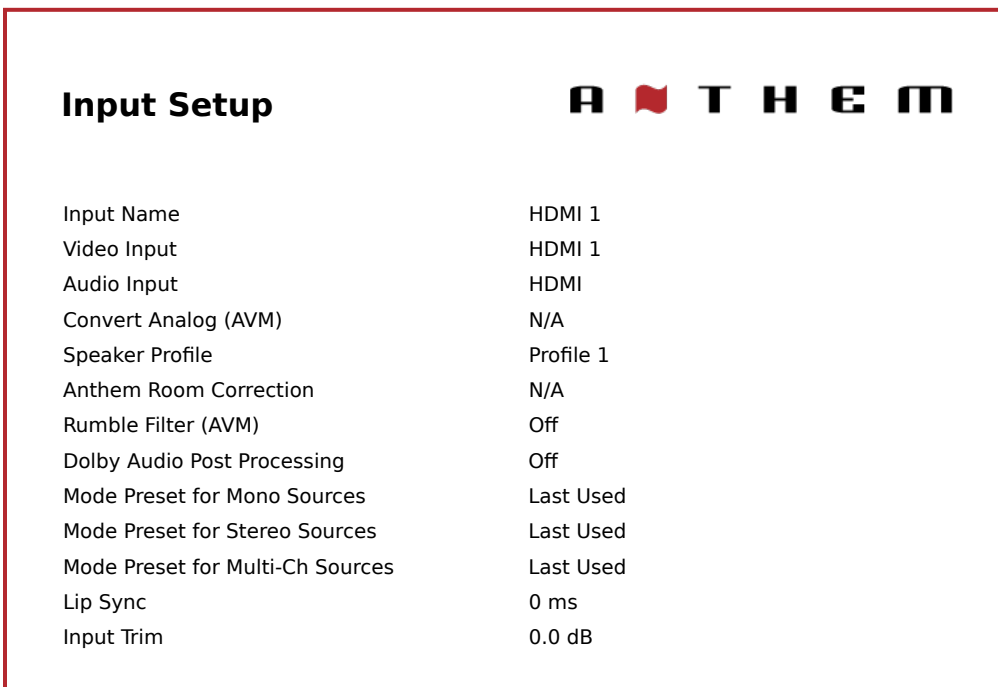

## Input Name

Each input can be renamed using the navigation keys and volume knob. Up to sixteen (16) characters are allowed for each name. When finished, press Select.

Example - Rename "HDMI 1" to "Blu-ray":

- Highlight "Input Name" and press SELECT. The first character is highlighted by a white box.
- Use the UP/DOWN remote buttons or volume knob to change "H" to "B."
- Use the PREV/NEXT buttons or LEFT/RIGHT on remote to move to each remaining character and complete the renaming.
- Press SELECT to return to the menu.

## Video Input

Select the connection to use: HDMI 1-7 or None. Use "None" if you are generating video directly on the TV. Ex. When using a streaming service through an app on your TV and using optical/eARC for audio back to the MRX, use "None" for video.

## Audio Input

Select the connection to use: HDMI, HDMI eARC, Coaxial 1-2, Optical 1-3, Analog 1-5, Streaming, Bluetooth, or MM (MM or "Moving Magnet" is only available on AVM).

## Zone 2 Input

Select the connection to use: HDMI, HDMI eARC, Coaxial 1-2, Optical 1-3, Analog 1-5, Streaming, Bluetooth, or MM (MM or "Moving Magnet" is only available on AVM)

## Convert Analog (AVM Only)

Setting this to "No" bypasses digital conversion and signal processing, and only level adjustments are available. No digital processing whatsoever will be used, including Anthem Room Correction. This option may be desirable for listeners using sources such as turntables.

## Speaker Profile

Select the profile to use with this input. This is where you can select previously made speaker profiles for different situations such as 7.1.4 vs. 2 channel.

## Anthem Room Correction

The ARC measurement process, described later, automatically turns this On. To disable room equalization afterward, change this to "Off." If room correction isn't loaded, "N/A" is displayed.

## Dolby Audio Post Processing (Main Zone Only)

Select "Music", "Movie", "Night" or "Off." Dolby Volume makes content with significant differences in volume easy to listen to by analyzing it and intelligently adjusting two things—level and frequency response. It does this continually without causing pumping and breathing artifacts that are common with traditional dynamic range compressors. In doing so, the volume setting is taken into account, as is our hearing's declining sensitivity to the lowest and highest frequencies relative to the midrange as their levels drop. The result is that the perceived frequency response remains constant while making quieter parts of the content more listenable.

## Mode Presets

A listening mode is processing that enhances source material by increasing the number of output channels. Each available mode performs this differently, providing a unique type of sound.

To find your preference, spend some time listening to various modes using various sources. To disable presets and make selections entirely on the fly, select "Last Used." To disable listening modes altogether, select "None."

AnthemLogic-Cinema lets you experience full impact home theater sound from any 2-channel source. This mode creates an extensive, enveloping, and dynamic listening experience, making 2-channel movies sound more like a state-of-the-art movie theatre. Through extensive listening tests, Anthem engineers developed this proprietary mode avoiding the use of echo effects, which could negatively affect the purity of the sound.

AnthemLogic-Music enhances the stereo listening experience without detracting from the stereo soundstage. This mode is also a minimalist design that uses no echo or reverberation effects. To ensure that the purity of the stereo music soundstage is not compromised when you're sitting in the "sweet spot" listening to your favorite stereo recordings, this mode uses no center channel.

## **Dolby Surround up-mixes all stereo, 5.1, and 7.1-channel content to take full advantage of all speakers in a Dolby Atmos system.**

Unlike previous wideband upmixing technologies, Dolby Surround can steer frequency bands individually, producing surround sound with precisely located audio elements and a spacious ambiance. Dolby Surround replaces the Dolby Pro Logic II family of upmixers, offering greater flexibility and superior audio performance.

DTS Neural:X uses all speakers in a DTS:X system for an immersive audio experience, creating separation by placing sounds at different points in the sound field. This mode does not apply to DTS:X Master Audio, DTS:X, Dolby Atmos, Dolby TrueHD, and Dolby Digital Plus sources.

All Channel Stereo mode sends the left and right channels to the surround channels with equal loudness while the center channel and subwoofer receive a combination of both.

All Channel Mono sums all channels and distributes an identical signal across all speakers. The only difference between each signal speaker will be determined by their crossover setting and therefore how much bass each will play.

### **Lip-Sync Delay**

If you hear the audio before seeing its corresponding image, you can set up to five hundred (500) milliseconds of audio delay. Set this using trial and error or a synchronization test disc. Movies are not always the best test because sounds, including dialog, are usually re-recorded after the filming is completed, and can be slightly out of sync at various points in the recording. While viewing a movie, you can also make adjustments after pressing the Lip-Sync button on the remote.

### **Input Trim**

If your inputs have varying degrees of volume causing spikes in volume as you change between inputs, you can normalize these by setting your input trim per input. This menu offers both + and - options for input trim but we recommend setting your quietest input at 0.0 dB and normalizing your louder ones around that by trimming them down, this is recommended because one input may be very loud and trying to turn the rest up to match it could clip the incoming signal.

## 5.6 PREFERENCES

Here you can set preferences as listed.

<b>Preferences</b>		<b>A T H E M</b>
Language	English	
Automatic Updates	No	
Beta Update	No	
Units	Feet	
Front Panel Brightness	10%	
Wake-up Brightness	60%	
On-Screen Info Display	16:9	
On-Screen Info Zone	Both Zones	
Front Panel Displayed Info	Volume Only	
Master Volume Scale	dB	
Mute Level	Silent	
Main Max Volume	+10.0 dB	
Zone 2 Max Volume	+10.0 dB	
Main Power-On Volume	-35.0 dB	
Zone 2 Power-On Volume	-35.0 dB	
Main Power-On Input	Last Used	
Zone 2 Power-On Input	Last Used	
Headphone Mutes Main Outputs	Yes	
Default Streaming Zone	Main	
Favor Current Streaming Input	Yes	
No Signal Power Off	20 Minutes	
Standby HDMI Bypass	Off	
Connected Standby	Enabled	
CEC Control	Off	
CEC Power-Off Control	Disabled	
HDMI Audio to TV	Off	
Mute Line-Out	None	
Mute Digital-Out	None	

### Language

Set the language you would like the menu to appear in.

### Automatic Updates

When "Yes" is selected, your MRX/AVM will automatically update to the latest firmware when it becomes available. To update firmware manually, you can read about it in the "Store / Load / Save" section of the manual.

### Beta Update

When "Yes" is selected, your MRX/AVM will become enrolled in our beta over-the-air receiver update program that provides updates to help with testing new software, which will either include bug fixes or new features.

Note that beta updates are not necessarily ready for full release and may introduce new bugs into your MRX/AVM (which can be resolved by reverting to the old software or waiting for the newer version of the beta software) if you are not comfortable with potential bugs, leave this setting at its default position "No".

## Units

Choose between imperial and metric versions of measurement.

## Front Panel Brightness

Set the preferred default brightness of the front panel. Note, when set to "Off," even the lights behind the power buttons are turned off. By default the MRX/AVM is set with 10% brightness, in most rooms this is a good setting but if your room is quite dark, the back-light may look too bright.

## Wake-Up Brightness

After pressing a button, the display can go to a brighter level for five seconds. Note that the minimum setting will change depending on your selected setting for FRONT PANEL BRIGHTNESS, this is to stop from the possibility of making the screen dimmer when pressing buttons.

## On-Screen Info Display

This setting affects the 2 line display that appears on-screen when changing settings such as input or volume. By default it is set to 16:9 which is the aspect ratio of the majority of televisions. 2.4:1 can be used with a wide projection screen to keep the 2 line display properly positioned in relation to the screen.

## On-Screen Zone Display

This setting affects the 2 line display that appears on-screen when changing settings such as input or volume. The information displayed here will always reflect what is being changed in the Main Zone. By default you can see changes happening on both the Main Zone and Zone 2 displays but you can limit the information to only be displayed on the Main Zone.

## Front Panel Displayed Info

Choose between "Volume Only" and "All" for information to be displayed on the front panel of the unit. "All" will include information such as incoming audio and video signals.

## Master Volume Scale

By default this is set to "dB" which is common for most modern receivers. dB references the volume trim of the incoming signal where "0.0 dB" is the unaltered signal coming in from a source, while this is the standard it can be confusing for new users. "%" offers a volume scale of 0-100 which is standard for computers, televisions and most sources.

## Mute Level

By pressing Mute, sound can turn off completely or decrease in volume by the amount that you select. This setting allows mute to decrease the volume while still keeping some in the background. Select from Silent or -5 to -30 dB in 5 dB steps.

## Maximum Volume

These settings allow you to limit the volume setting to avoid damaging equipment or hearing.

## Power-On Volume

This setting controls a volume level to use when first powering the MRX/AVM. To power-on at the last used volume, select "Last Used" by changing the value to less than -90.

## Power-On Input

This setting controls which input to use when first powering on the MRX/AVM. Select from one of the available inputs or "Last Used."

## Headphone Mutes Main Outputs

Changing this to "No" allows the speakers to continue playing with headphones plugged into the front panel.

## Default Streaming Zone

Choose between the Main Zone and Zone 2. This option will determine where your streaming is automatically sent once you start streaming to the MRX/AVM.



## **Favor Current Streaming Input**

When set to no, streaming to the unit will force it to switch to the default streaming zone. If set to yes, the stream will follow whichever zone you are on.

## **No Signal Power Off**

When there is no input signal, the MRX/AVM turns off after the selected time: 5, 10, or 20 minutes, 1, 2, or 6 hours, or "Never." Default is 20 minutes.

## **Standby HDMI Bypass**

This option allows the use of an HDMI source without turning on the MRX/AVM. Select HDMI 1-7, or "Last Used." The standby LED on the front panel changes to red. Your television may need to be set to allow the sound to come from its speakers. Check its manual. After changing CEC settings, or loading factory defaults, it may be necessary to briefly disconnect and reconnect the HDMI cable between the MRX/AVM and TV or source component for the new settings to be recognized.

## **Connected Standby**

When disabled, the AVM/MRX goes into a low-consumption standby mode and does not sense IP commands while in it. To make it respond to a power-on command or so it can be used immediately after power on, enable this setting. This can also be used with RS-232 control to avoid sending a wake-up command.

## **CEC**

When enabled, Consumer Electronics Control allows controlling an HDMI-connected component using another brand's remote control (as long as the other components have CEC enabled). Note that when components are from different brands, this control system may not be reliable.

With CEC, turning on one component in the system can turn on the rest of the system, the same as turning one component off. You may or may not want this, which is why we provide separate options for CEC Power Off Control and CEC Power On Control. When either setting is disabled, the MRX/AVM ignores corresponding power commands sent by other HDMI-connected components.

## **HDMI Audio to TV**

This option allows you to divert the audio signal from your MRX/AVM directly to the TV.

## **Mute Line Out or Digital Out**

If using a recording device, select the input to which the recorder's output is connected. This setting prevents the recorder's output from being fed back to its input, which can result in a loud noise.

## 5.7 NETWORK / CONTROL

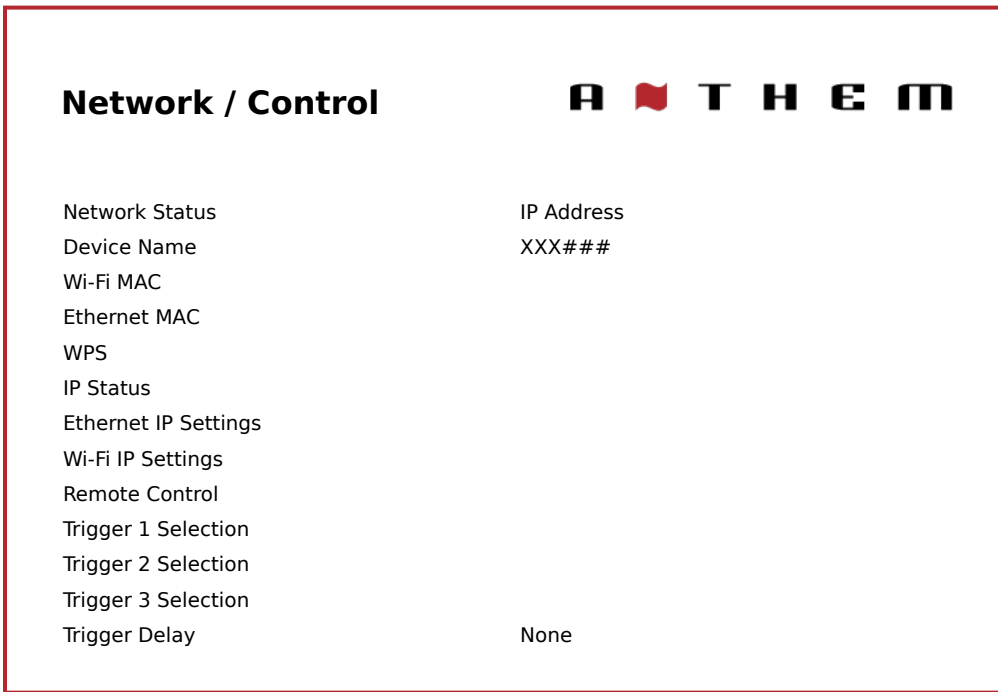

### Network Status

After the MRX/AVM connects to a local area network, the device's IP address displays here.

### Device Name

This option sets the name that the MRX/AVM broadcasts, and can be changed using up to 16 characters.

### Wi-Fi / Ethernet MAC Address

This displays the two MAC addresses that belong to your MRX/AVM, one if you are using wireless control and another for an Ethernet connection. MAC addresses are used for identifying your MRX/AVM on your network and cannot be changed.

### WPS

Use this method if your router has a WPS (Wi-Fi Protected Setup) button. After making the menu selection, press the button on your router. Or, enable push-button mode by holding the Wireless button on the MRX/AVM's rear panel for 5 seconds. The LED next to it should change its blink style. (tap again to cancel).

### IP Configuration

Settings in this submenu should only be changed if your network administrator gives the direction.

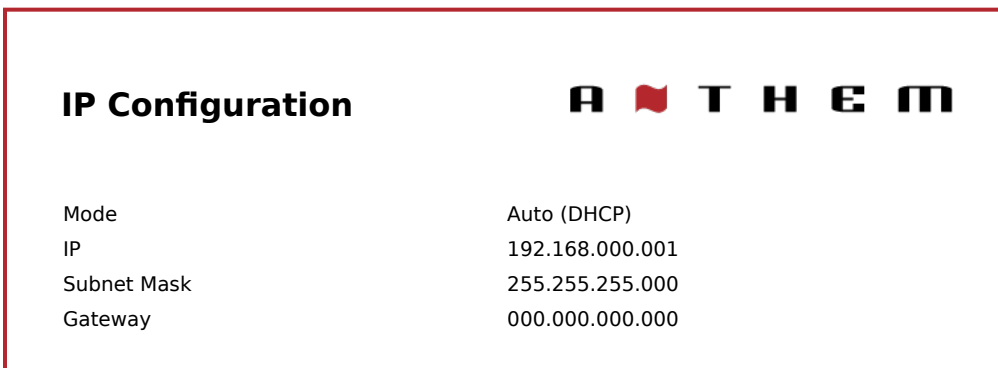

## Mode

Static IP settings take effect once this setting changes to “Manual.”

## Remote Control

This menu offers more advanced control settings.

IP Configuration		A N T H E M	
TCP Port	14999		
Rear IR	On		
Front IR	On		
Tx Status	IP Only		

## TCP Port

Change this only if there is a conflict with another application that uses 14999. Available settings are 1025 to 49150. TCP Port is required for Anthem Room Correction.

## Rear and Front IR

This setting allows you to disable each of the MRX/AVM's infrared inputs, which can be useful when the MRX/AVM is connected to an IR repeater and is receiving too many signals.

Note that after you disable the front and rear IR inputs, you can no longer control the MRX/AVM with the remote control. You can re-enable the IR inputs using the front panel buttons. If your remote control is not working and you have already checked the batteries, check these settings next before contacting technical support.

## TX Status

Choose whether all commands, status changes, and control information report through the Ethernet and RS-232 connections or Ethernet only.

## Trigger

When connected to the trigger input of another component, such as an amplifier or projector, the MRX/AVM's trigger output can turn the connected device on or off according to the trigger's setup.

## MRX 540

Trigger Selection		A N T H E M	
Trigger Control	Menu		
Power	Main or Zone 2		
HDMI 1	Off		
HDMI 2	Off		
HDMI 3	Off		

In the example shown, the trigger activates while Main or Zone 2 power is turned on. Trigger outputs can also be set to activate according to any combination of inputs instead of Power.

If controlling triggers through IP or RS-232, change "Menu" to "RS-232/IP."

### Trigger Delay

Choose whether your trigger is delayed or not. This can be useful if there is a "pop" when something turns on too soon after the MRX/AVM.

## 5.8 STORE / LOAD / UPDATE

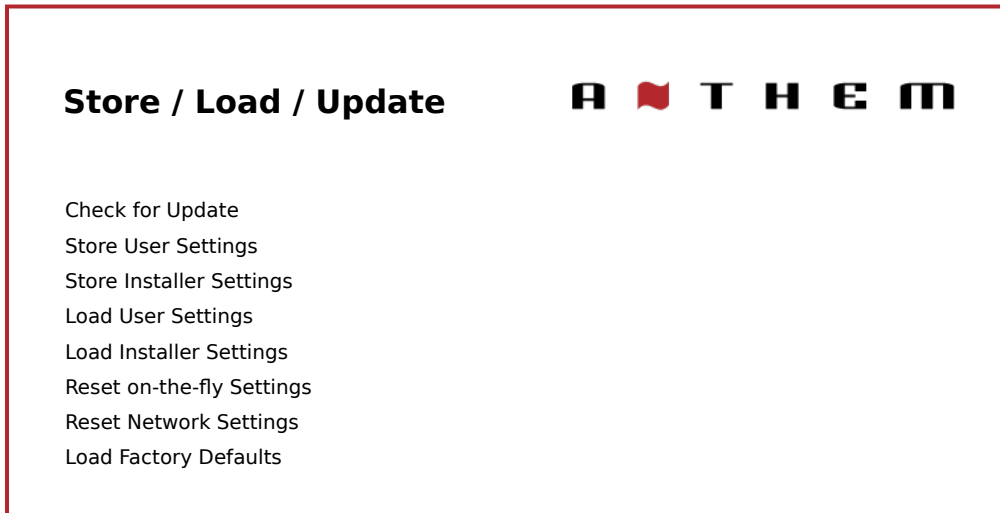

### Check For Update

This option requires an internet connection. When you select this option, it will scan for a software update and prompt to update if one is found. If you have "Automatic Updates" enabled in the preferences menu, you will not have to check for updates manually.

To update unit by USB, you must contact technical support.

### Store/Load User Settings

Selecting Save User Settings and confirming saves all menu settings. If you change settings later and want to recall the saved settings, select Load User Settings, and press SELECT.

### Store/Load Installer Settings

This offers the same functionality as the SAVE/LOAD user settings but offers you a second option for an installer to save their settings when they leave. This can be useful if user settings are modified to a point where there are issues, so they can revert back to the settings where the installer last left them.

### Reset On-The-Fly Settings

Selecting and confirming this option resets all non-menu settings such as level and bass/treble.

### Load Factory Defaults

Selecting and confirming this option resets all menu settings to the factory defaults. This option does not reset network settings.

### Reset Network Settings

Selecting and confirming this option resets all network settings.

## System Reset

This process is not available using the on-screen menu. To manually reset the MRX/AVM to factory condition: connect power, and press the front panel Menu and Main Power buttons at the same time. The unit should turn on. This process is useful if the MRX/AVM has become inoperable. However, the method described above wipes all user settings. Before doing this, try manually rebooting the MRX/AVM first:

- Disconnect the power cord.
- Press the front panel power button five times to drain any residual power.
- Reconnect the power cord.
- Power on the MRX/AVM.

## 5.9 SYSTEM INFO

### System Info



Release Version	1.0.0
Release Build Date	Jan 1 2021
Networking Module Version	0.01
MCU Version	0.01/0.01
DSP Version	0.01
DTS Version	IMAX Version
OSD Version	0.01/0.01
LCD Version	0.01/0.01
ARC Name	
ARC Date	
Serial Number	

### ARC Name

This item shows the name that you gave to your ARC measurement file.

### ARC Upload Time

This item shows the date and time that your ARC file was uploaded.

# 6.0 ANTHEM ROOM CORRECTION

## 6.1 ANTHEM ROOM CORRECTION (ARC®)

Please visit [AnthemARC.com](http://AnthemARC.com) for detailed information about using Anthem Room Correction.

The most significant detriment to the sound of an audio system is almost always the room it resides within—especially true in the realm of bass. Even in a professionally treated sound room, bass can quickly become boomy or anemic. Anthem Room Correction helps audio systems sound their best in any space. ARC offers a robust suite of tools to tame your wild sonic frontier—whether you have a tricked-out home theater, a traditional living room with carpet and thick drapes, or a modern floor plan with large open spaces and acoustically reflective furniture and windows.

Have you ever tested the acoustics in an empty room by whistling or clapping? It brings to mind how sound is affected by a room's size, structure, and contents. Even when using optimally positioned speakers of exceptional quality, the room negatively impacts sound quality considerably. Surfaces such as windows and furnishings and the geometry of the walls, floor, and ceiling add unwanted resonance and coloration, making the bass either boomy or less punchy, voices less natural, and dialogue less intelligible. The effect on frequency response is typically  $\pm 6$  dB in the midrange and  $\pm 10$  dB at low frequencies.

To compensate for this and to optimize the in-room response of your speakers, Anthem Room Correction measures the output of each speaker relative to the listening area then, through a series of calculations, adjusts its output. Not only does ARC correct peaks and dips in a speaker's frequency response, but it also preserves the beneficial acoustic attributes of a room—attributes based on proven psychoacoustic science (the study of how humans hear and experience sound).

In the sample curves provided here, the red curves represent the in-room response before correction, as an average from five measurement positions. In contrast, the green ones show a response with equalization applied. The black curve represents the target response. In this case, a subwoofer and bass management are also in use.

The default correction range, as shown below, is 5,000 Hz. This range can be changed to a higher or lower frequency if desired, although raising it is not recommended. At higher frequencies, the microphone becomes directional, thus affecting measurement accuracy. Note the rise in the measured and corrected response below 200 Hz. This rise shows the amount of room gain. ARC preserves the natural room gain of the room or allows you to adjust the amount of room gain if you wish.

The subwoofer graph may imply that the subwoofer plays up to the highest frequency shown, but what it plays depends on what the other channels send to it as determined by their crossover setting. The subwoofer graph shows the available correction range, which is not necessarily the range that other channels send to it through bass management.

## 6.2 USING ARC WITH AN MRX/AVM

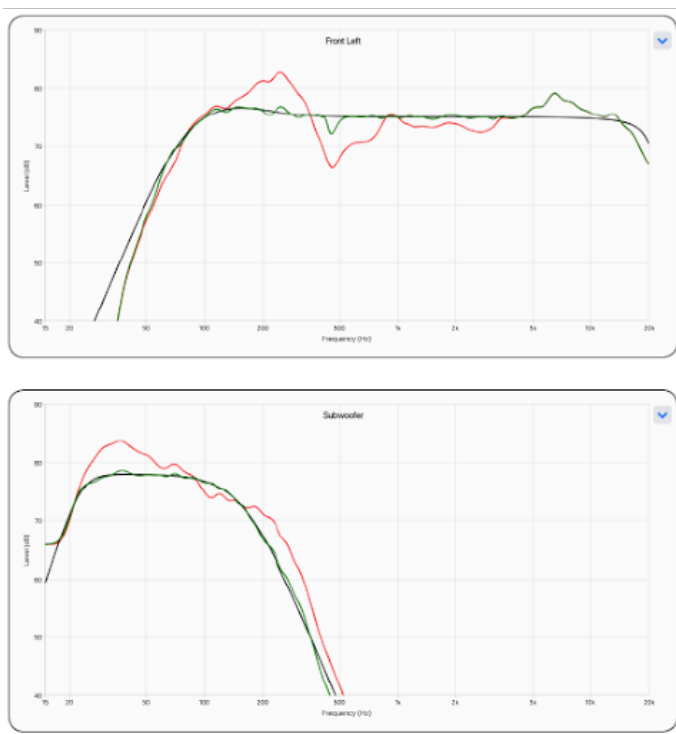

In addition to correcting the acoustic response of subs and speakers, ARC also:

- Adjusts the left/right balance of the speakers.
- Sets the crossover point between the speakers and subwoofer (do not manually change this after running ARC).
- Adjusts the subwoofer's level relative to the speakers.
- Adjusts the subwoofer's phase/polarity relative to the speakers.

Before using Anthem Room Correction:

- Enable subwoofers (if applicable).
- Measure and set distance (can be down afterwards as well)

To use Anthem Room Correction:

1. Download and install the program from [AnthemARC.com](http://AnthemARC.com) (the beta version is required for x40 MRX/AVM units)
2. Start the program and select Launch ARC from the first screen.
3. Select the MRX or AVM from the device discovery screen.
4. Follow the on-screen instructions to measure the room, calculate correction curves, and upload them to the MRX or AVM.



# 7.0 OPERATION

## 7.1 POWER ON / OFF AND VOLUME

Main and Zone 2 have separate power controls. During power-on and power-off, MRX/AVM produces a mechanical click (this is normal). Volume comes on according to the menu “Main Power On Volume”/ “Zone 2 Power On Volume” settings.

### Remote

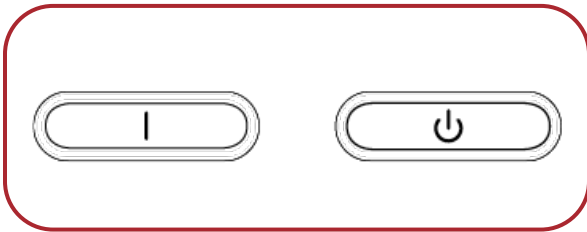

To control volume, rotate the front panel knob or press VOL up/down on the remote control. To mute or un-mute the audio, press MUTE on the front panel or remote.

### Front Panel

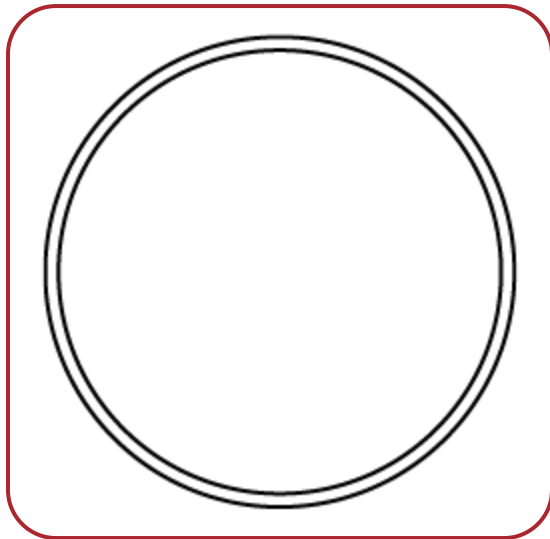

### Remote

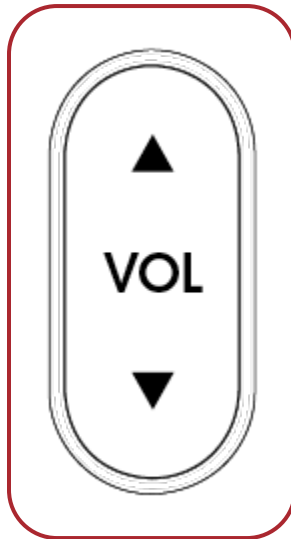

## 7.2 ZONE 2 OPERATION

To operate Zone 2 using the remote control, use these buttons:

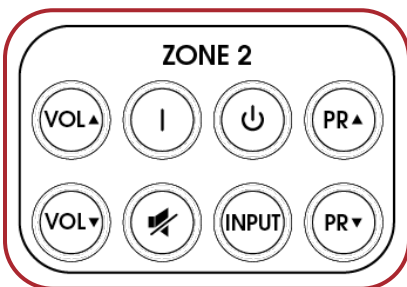

## 7.3 INPUT SELECTION

The number of active inputs varies according to how the Input Setup menu was programmed. To scroll through the active inputs, press PREV/INPUT or NEXT/INPUT on the front panel or press the right/left buttons on the remote, and to make a selection press SELECT.

**Front Panel**

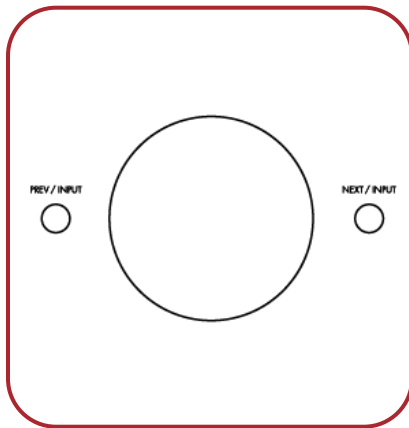

**Remote**

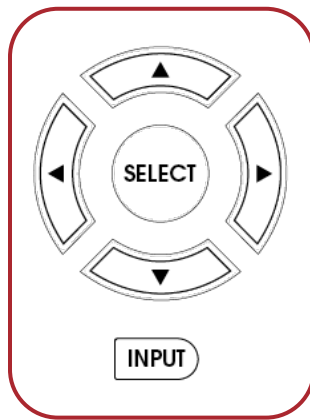

Alternatively, press the INPUT button for an on-screen list of inputs. Use the left/right or prev/next and SELECT buttons to change the input.

To select the next input in Zone 2, press the INPUT button (after pressing the ZONE button if using the front panel).

## 7.4 LEVEL TRIM

If a channel group, for example, the surrounds or the subwoofer, occasionally sounds too loud or soft, adjust its level on the fly—press LEVEL on the remote to cycle through the groups then up/down to adjust. Note, LFE is a separate adjustment from the subwoofer. LFE can be used to reduce the level of LFE effects on multichannel recordings without affecting the bass redirected from other speaker channels. The subwoofer adjustment changes both the redirected bass and LFE levels. Also keep in mind that ARC will balance all channels to be equal and you should wait to adjust on-the-fly settings until after running ARC.



Do not use these controls, intended for on-the-fly adjustments, for system calibration. System calibration should be completed using Anthem Room Correction or the setup menu.

## 7.5 BASS / TREBLE / BALANCE

To change the tone of your system, press BASS or TREBLE on the remote control then the up/down buttons. Note that BASS does not affect the subwoofer output, which is handled by the Level adjustment.

To change balance, press BAL on the remote. Then, press up to move the image to the right or down to move the image to the left.

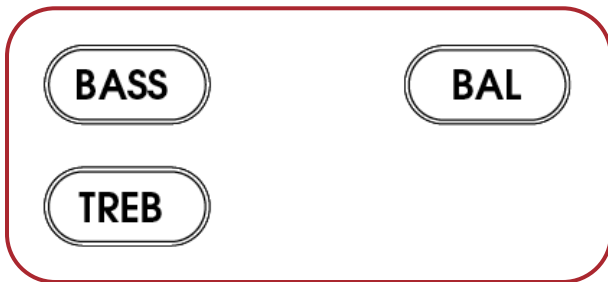

## 7.6 LIP-SYNC

If the audio is not synchronized with the video, press LIP-SYNC then up/down to add as much as 500 milliseconds of delay. Adjusting the lip-sync permanently changes the lip-sync setting of the current input.



## 7.7 LISTENING MODES

Refer to the Input Setup section for a description of listening modes. Once the MRX/AVM's display shows the input format, the listening mode preset is applied. If you wish, you can make a different selection after pressing the MODE button.



At times it might appear that the MRX/AVM is detecting a sound format different from the one that you would like to be playing. Note that the source is in control and that the connection to the MRX/AVM carries one format at a time. To ensure audio sent to the MRX/AVM is in its original format:

1. In the source's setup menu, set digital audio output to Bitstream mode for all Dolby Digital and DTS formats.
2. If the source is a Blu-ray player, also ensure that Secondary Audio is disabled.
3. If the source material is on Blu-ray or DVD, you may want to select an audio track other than the disc's default. There are two ways to do this: through the audio or language setup in the disc's menu, or during the movie by pressing AUDIO on the player's remote control.

## 7.8 DOLBY AUDIO POST PROCESSING AND DYNAMIC RANGE CONTROL

Refer to the Input Setup section for a description of Dolby Audio Post Processing. To change on/off status, press DYN on the remote control and then the up/down buttons.



When Dolby Audio Post Processing is off, and you press the DYN button a second time, alternate dynamic range settings become available. This setting allows you to control the difference between the softest and loudest passages on soundtracks that contain dynamic scaling cues.

## 7.9 DTS:X DIALOG LEVEL CONTROL

This control applies only to DTS:X sources making use of the function. To raise or lower the level of the dialogue (actor voices), use the PG/PR up/down buttons on the remote. The range is 0-6 dB, default 3 dB.

Note that not all soundtracks are recorded with a separate dialogue track and therefore won't be able to use this feature.

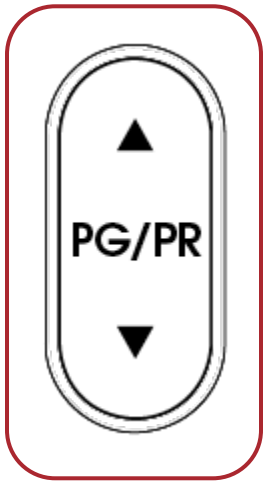

## 7.10 DISPLAY BRIGHTNESS

To change the brightness of the front panel display and LED indicators, press DIM then up/down to move between 1% and 100%.



## 7.11 INFO DISPLAY

Pressing the info button toggles between "Volume" and "All Info" on your MRX/AVM display.

## 7.12 AIRPLAY SETUP

### **Wired Connection**

1. Connect an ethernet cable to the Receiver/Processor.
2. To listen to audio via AirPlay on your Receiver/Processor, ensure your Apple device is connected to the same network as the Receiver/Processor and simply select the Receiver/Processor as the AirPlay audio playback device.

**Note:** The Receiver/Processor will appear as MRX/AVM in the AirPlay speaker menu.

### **Wireless Connection**

Ensure your Apple device is connected to the wireless network you wish to connect the Receiver/Processor to.

1. Enter the Wi-Fi Settings Menu.
2. Locate MRX/AVM under "Set up new AirPlay speaker."
3. Select the unit you wish to connect and allow it to connect to your network.

**Note:** The Receiver/Processor will appear as MRX/AVM in the AirPlay speaker menu.

## 7.13 CHROMECAST SETUP

### Wired Connection

Connect an ethernet cable to the Receiver/Processor.

### Wired & Wireless Connection

Download and open the Google Home app.



1. You should be prompted that there is a device available for setup. If not, simply tap "Add" followed by "Setup a Device." Select the Receiver/Processor and follow the instructions on screen.
2. To listen to cast audio from any supported application on your Receiver/Processor, ensure your device is connected to the same network as the Receiver/Processor.
3. Tap the Chromecast built-in icon from within the application and select the Receiver/Processor as the playback device.

### Bluetooth Setup

Bluetooth connection requires both wireless antennas to be attached. Once the antennas are attached, you must be on the Bluetooth input for the MRX/AVM to enter Bluetooth pairing mode. Note that when you switch off of the Bluetooth input or change inputs, the MRX will lose the pairing. The unpairing happens because Bluetooth was designed for individual speakers and if it automatically reconnects to the receiver, it can switch your input and play unwanted audio from something like background audio on a website that may be too loud.



# LIMITED WARRANTY

## CANADA & USA

The warranty period on new Anthem products is:

5 years: Separate power amplifiers and integrated amplifiers 3 years: Audio/Video preamplifiers and receivers

Please register your product at [www.anthemAV.com](http://www.anthemAV.com)

The warranty period begins on the date of purchase from Anthem or an Authorized Anthem Dealer. This warranty is offered only to the original owner and is not transferable. Demonstration and display units are covered by the same warranty except that the period commences on the date of dealer invoice, not the purchaser's invoice, and cosmetic flaws are excluded.

If Anthem determines that the product has a defect in materials or manufacturing during the warranty period Anthem will at its option repair, replace or provide the necessary replacement parts without charging for parts or labor. Repaired or replaced equipment or parts supplied under this warranty are covered by the unexpired portion of the warranty.

Warranty is void if the serial number has been removed, altered or defaced, if the product has been operated, installed or handled other than in accordance with the intended application, tampered with, modified, or damaged by accident, while in transport or by failure of electric power, or has been repaired by a non-authorized party. Anthem shall have no obligation to correct any defect that is not reproducible by Anthem. If inspection by Anthem discloses that the repair required is not covered by this warranty, regular repair charges shall apply.

If a problem is discovered in your Anthem product, please contact the Authorized Anthem Dealer from whom you purchased the product. Your dealer will help to determine the cause of the problem and arrange for the appropriate action. Alternatively, follow the procedure below for factory service.

A Return Authorization (RA) number must be obtained from Anthem Technical Support before a product can be shipped to Anthem for any reason. Product shipped to Anthem without its RA Number clearly visible on the outside of the shipping carton will be refused and returned to the sender, freight collect. Product shipped to Anthem must have shipping and insurance prepaid by the sender, be packaged in the original carton and packing material and accompanied by a written description of the defect. Service will not be given under warranty without an accompanying copy of the sales invoice. Product repaired under warranty will be returned with shipping and insurance prepaid by Anthem (within Canada and continental USA only).

## DISCLAIMER OF LIABILITY

Under no circumstances shall Anthem, its agents, representatives or employees assume liability or responsibility for injury or damages sustained in the use or operation of Anthem products or for damages to connected products. Some jurisdictions do not allow limitations of incidental or consequential damages so this exclusion may not apply to you.

Anthem reserves the right to make design changes without obligation to revise prior versions. All specifications are subject to change without notice.

This warranty shall be the sole and exclusive remedy to you. No other warranty or condition, statutory or otherwise, expressed or implied, shall be imposed upon Anthem nor shall any representation made by any person, including a representative or agent of Anthem, be effective to extend the warranty coverage provided herein.

On the expiration of the warranty all liability of Anthem in connection with the product shall terminate.

## INTERNATIONAL

Terms and conditions are set and maintained by the Authorized Anthem Distributor, not Anthem.



**A  T H E M<sup>®</sup>**



+1 905-564-1994  
8:30 am - 5:00 pm M-F (ET)

[www.anthemAV.com](http://www.anthemAV.com)